

DISCONNECTOR

Type **BWU15.08/BWU30.08**

RAIL VEHICLES

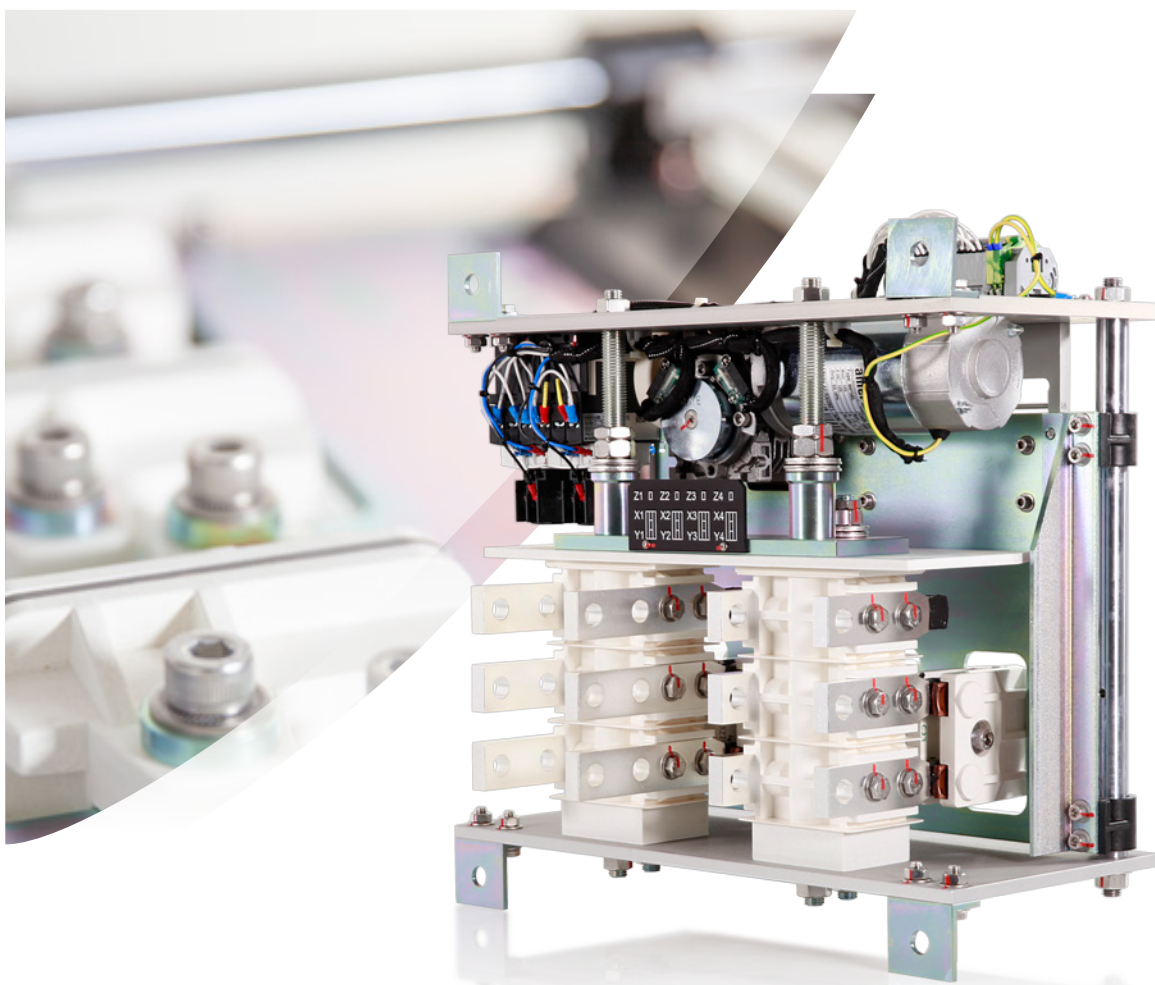

GENERAL INFORMATION

The BWU series of changeover switches were developed to meet the need for an economically priced, modern device which satisfies the technical requirements and constraints (e.g. lack of available space) imposed by modern traction vehicles. In other words, a functionally optimized selector switch replacing the traditional reversers and motoring/braking switches positions. The different circuit arrangements of the commutator-type motors of electric traction vehicles are set up by changeover switches.

These changeover devices may be used as direction reversers, motoring/braking changeover switches, converter or traction motor disconnect switches, series/parallel grouping switches, power system selector switches or transformer tapchangers. In every case switching always takes place in the de-energized state and there are either two or three switch positions. The switches themselves are designed as offload switches, nor for breaking nor making currents. They are motorized actuated.

APPLICATIONS, TYPICAL EXAMPLE

- Example application for AC vehicles

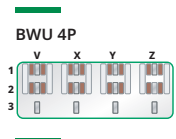
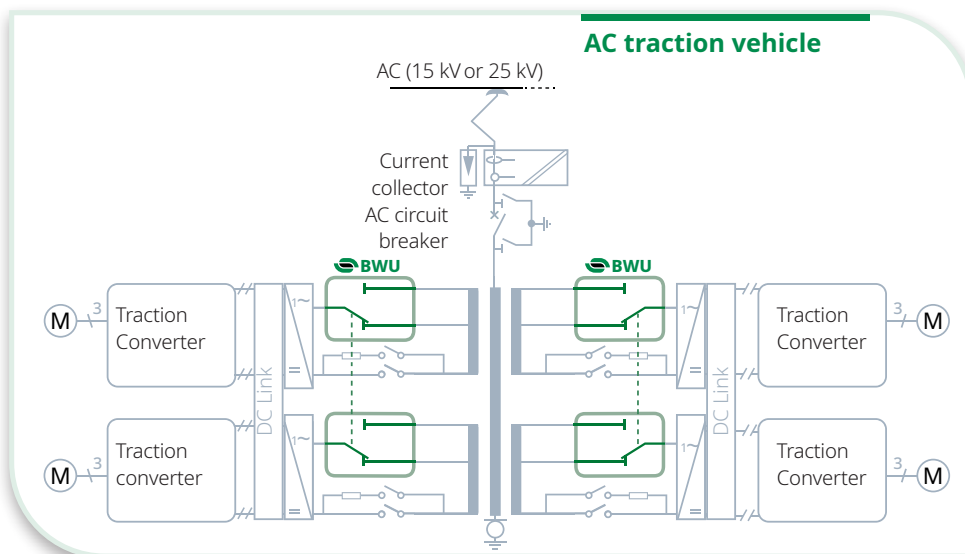

- Example application for AC/DC vehicles

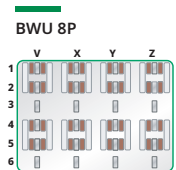
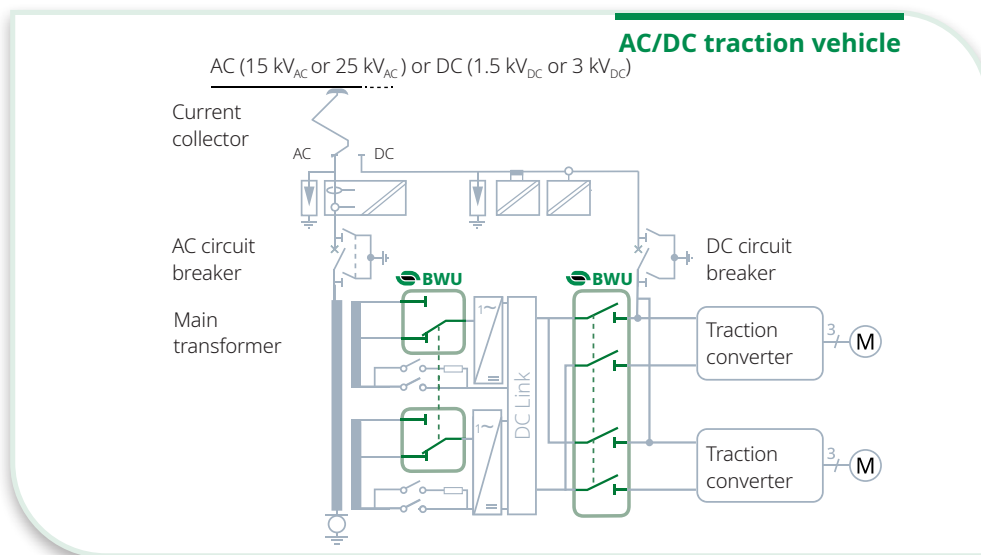

MAIN FEATURES

- Rated operational voltage up to 3,600 V
- Rated thermal current 750 A
- Multi-poles versions up to 36 poles
- High overvoltage category OV3
- High resistance to pollution degree PD3
- Compliant with standards
EN / IEC 60077-1/-2 ; IEC 60850 / EN 50163 ;
EN 50125-1 / IEC 62498-1 ; EN / IEC 60529 ;
IEC 62497-1 / EN 50124-1 ; EN / IEC 61373

MAIN BENEFITS

- ✓ For applications with high quantity of poles in restricted volume
- ✓ Can be used for different types of function: disconnector or/and changeover
- ✓ Electric control or manual for bi-stable operation
- ✓ Integrated interlocked contactors for motor control
- ✓ Highest operational frequency class C3
- ✓ Multiple fixation and installation options
- ✓ Extensive factory reliability testing
- ✓ Proven design with decades of operation worldwide
- ✓ Low maintenance & low Total Cost of Ownership (TCO)

PRODUCT STRUCTURE & FUNCTIONAL SCHEME

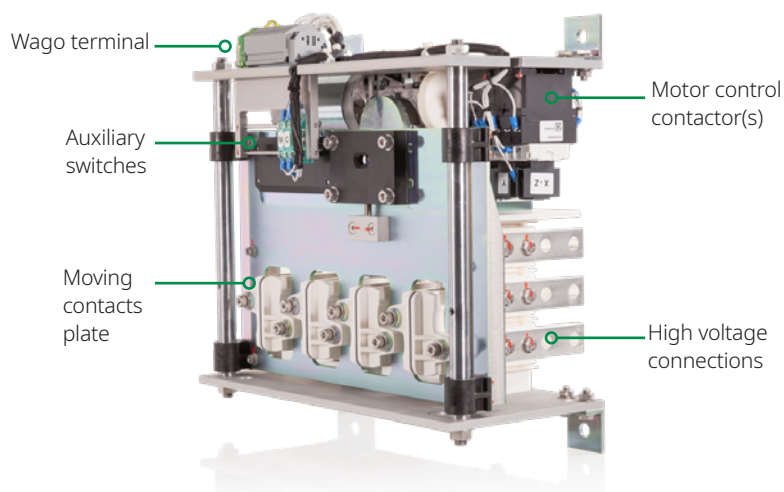
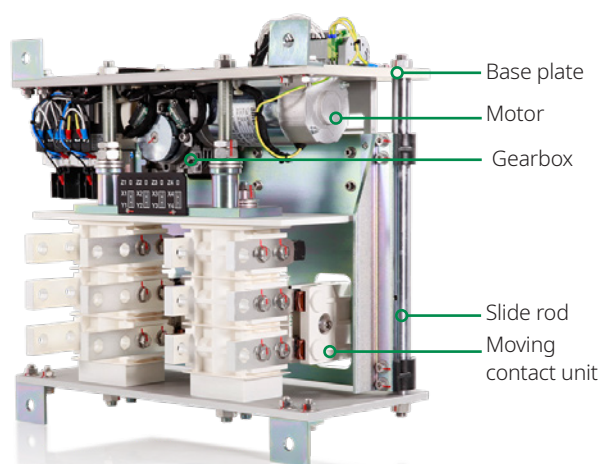

PRODUCT RANGE

AVAILABLE BWU CONFIGURATIONS

U [V= / V~]

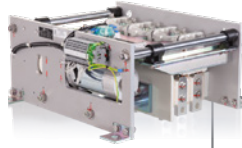
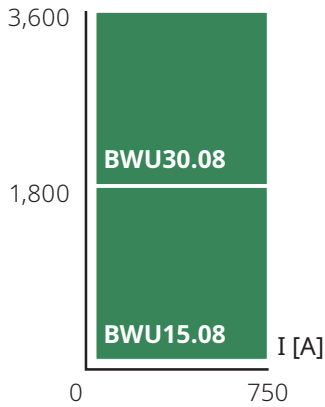

	Number of terminals		
	4 poles	8 poles	12 poles
Changeover disconnector	12	24	36
Direction reverser	-	20	28
Customized Multipole	-	22	32

The BWU poles are mechanically connected.

AVAILABLE BWU APPLICATIONS

Typical applications

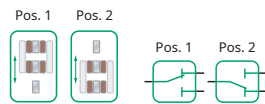

Changeover / disconnector

BWU configurations

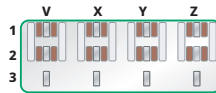

12 terminals

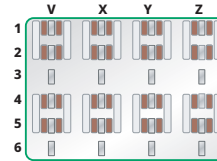

24 terminals

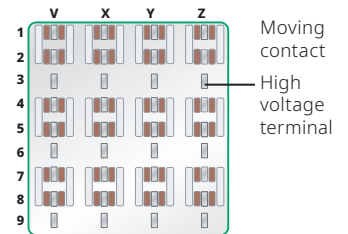

36 terminals

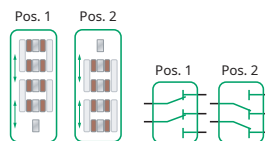

Direction reverser

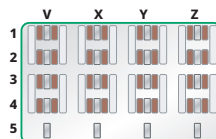

20 terminals

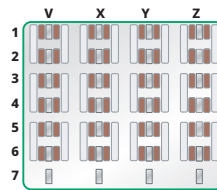

28 terminals

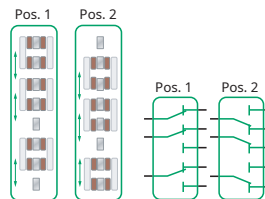

Customized

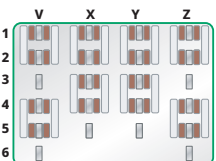

22 terminals

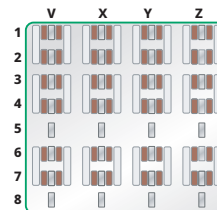

32 terminals

Both changeover and disconnector contacts configurations can be mixed on the same BWU.

Other configurations are available please contact Sécheron.

DATA FOR PRODUCT SELECTION

	Symbol	Unit	BWU 15.08	BWU 30.08
MAIN HIGH VOLTAGE CIRCUIT				
Rated operational voltage	U_r	[V]	1,800	3,600
Rated insulation voltage	U_{Nm}	[V]	1,800	3,600
Application			AC or DC	AC or DC
Oversvoltage category ⁽¹⁾			OV3	OV3
Pollution degree ⁽¹⁾			PD3	PD3
Conventional free air thermal current ⁽²⁾	I_{th}	[A]	750	
Overload capacity ⁽²⁾ 1h	I_{adm}	[A]	800	
Operational frequency classes			A4 / C3	
Minimum creepage distance ⁽¹⁾		[mm]	22.5	45
Clearance distance ⁽¹⁾		[mm]	14	33
Rated power-frequency voltage	U_a	[kV]	5.5	11.5
Rated impulse voltage	U_{Ni}	[kV]	12	25
Peak and rated short-time withstand current / duration	$I_p/I_{CW}/t$	[kA/kA/s]	50 / 20 / 1	

⁽¹⁾ According to standard IEC 62497-1 / EN 50124-1. ⁽²⁾ At $T_{amb} = +40^\circ\text{C}$.

LOW VOLTAGE AUXILIARY CIRCUIT

Control circuit

Type of control			Electric	
Nominal voltage	U_n	[VDC]	24 to 110	
Variation of supply voltage	U_n		0.7 to 1.25	
Control power ⁽³⁾	P	[W]	≤ 125	
Opening or closing time ⁽³⁾	t_o	[s]	≤ 3	
Rated power frequency voltage ⁽⁴⁾	U_a	[kV]	1.5	

⁽³⁾ At U_n and $T_{amb} = 25^\circ\text{C}$. ⁽⁴⁾ At 50 Hz at 60s.

Auxiliary contacts

Type of contacts			Potential free (PF)	
Auxiliary contacts	N		2a(NO)+2b(NC) 6a(NO)+6b(NC) (option)	
Conventional thermal current			10	
Switching categories according to EN 60947 (silver contacts)				
- AC-15			$< 230 V_{AC}$ 1.0 A	
- DC-13			110 V_{DC} 0.5 A	
Minimum let-through current at 24 Vdc		[mA]	≥ 10 (silver contacts) or $4 \leq I < 10$ (gold contacts)	

Low voltage interface

Type of connection			Terminal block as standard Harting connector as option	
--------------------	--	--	---	--

Insulation

Rated power frequency voltage (50 Hz/1 min)		[V]	1,500	
---	--	-----	-------	--

⁽²⁾ At $T_{amb} = +40^\circ\text{C}$ and tested with high voltage connections according to standard IEC/EN 60943.

OPERATING CONDITIONS

Installation			Indoor	
Mounting position			Horizontal, side or vertical	
Working ambient temperature	T_{amb}	[°C]	-40°C to +75°C	
Altitude		[m]	≤ 2000 m without restriction	
Humidity EN 50125-1 / IEC 62948-1			Class Tx	
Shocks and mechanical vibrations EN/IEC 61373			Category 1 class B	
Protection index:				
- HV part			IP00	
- LV part			IP00	
Rated mechanical durability	N	Cycles	250,000	

PRODUCT INTEGRATION

MAIN DIMENSIONS (TYPICAL PROJECT)

HV connections	2 x M14
Earth connections	M13 screws
LV Connections	Terminal block as standard
Fixing points	M14 screws

Dimensions are indicative. All dimensions are in mm. The maximum allowed flatness deviation of the support frame is 0.5 mm.

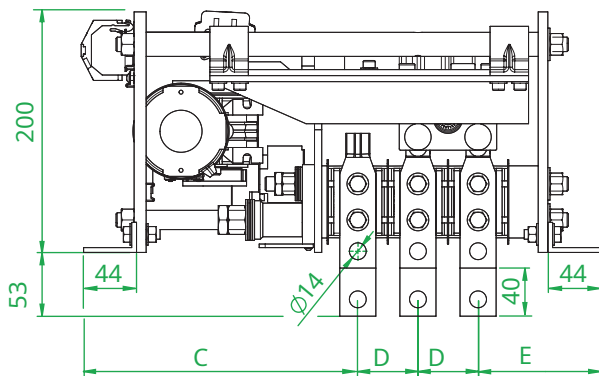

BWU..08E
Horizontal/vertical installation

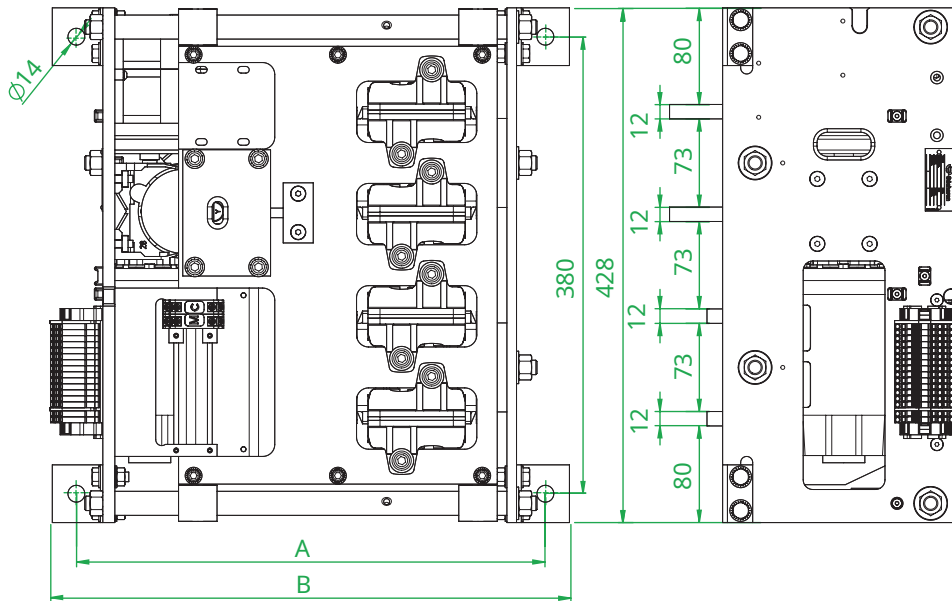
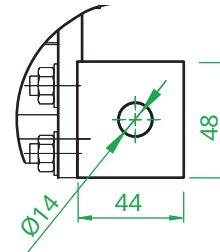

	BWU 15.08						BWU 30.08					
	3	5	6	7	8	9	3	5	6	7	8	9
Levels												
A	386	486	536	586	636	686	460	600	670	740	810	880
B	430	530	580	630	680	730	500	740	810	880	950	1,020
C	228						258					
D	50						70					
E	102						102					
Numbers of contacts	12	20	24	28	32	36	12	20	24	28	32	36
Weight (kg)	30.5	47.5	56	64.5	73	81.5	33.5	53.5	63.5	73.5	83.5	93.5

INSTALLATION POSSIBILITIES

WORKING POSITIONS

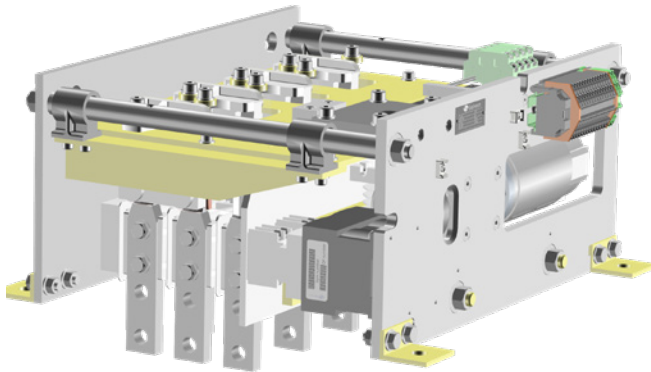

HORIZONTAL POSITION
STANDARD

BWU...08

side/vertical
option

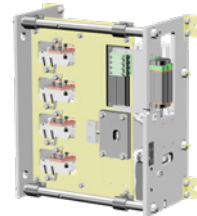

SIDE POSITION
OPTION

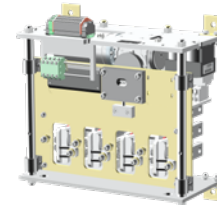

VERTICAL POSITION
OPTION

DEVICE FIXATIONS

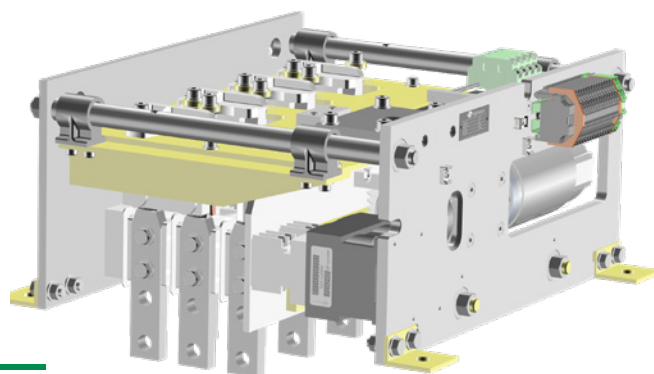

FIXATION OUTWARDS
STANDARD

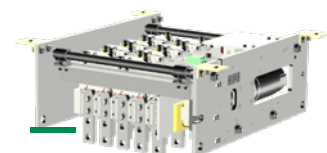

FIXATION OUTWARDS UP
OPTION

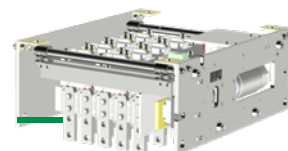

FIXATION INWARDS UP
OPTION

DESIGNATION CODE FOR ORDERING

- Be sure to establish the designation code from the latest version of our brochure by downloading it from the website: www.secheron.com.
- Be careful to write down the complete alphanumeric designation code with 16 characters when placing your order.
- For technical reasons some variants and options indicated in the designation code might not be combined, therefore validate your configuration with Sécheron before ordering.
- For other configurations not described in the brochure, please contact Sécheron.

Example of customer's choice:	BWU	15	08	C	3	E	A	1	Z	W	H	1	Z
Line:	10	11	12	13	14	15	16	17	18	19	20	21	22

The bold characters of the designation code define the device type.

Note: some combinations may not be possible, therefore validate your configuration with Sécheron before ordering

DESIGNATION CODE

Line	Description	Designation	Standard	Options	Customer's choice
10	Product type	BWU	BWU		BWU
11	Rated operational voltage	1,800 V 3,600 V	15 30		
12	Rated conventional free air thermal current	750 A	08		08
13	Type	Changeover / Disconnecter Reverser Customized, please contact Sécheron	C	R X	
14	Number of levels	(C type only) (R type only) (C or X type only) (R type only) (X type only) (C type only)	3	5 6 7 8 9	
15	Operation	Electric	E		E
16	Nominal supply voltage	24 V _{dc} 36 V _{DC} 48 V _{DC} 72 V _{DC} 110 V _{DC} 125 V _{DC}	E	A B C D F	
17	Auxiliary contacts per pole	2a (NO) + 2b (NC) - (switch PF) - silver type 4a (NO) + 4b (NC) - (switch PF) - silver type 6a (NO) + 6b (NC) - (switch PF) - silver type 2a (NO) + 2b (NC) - (switch PF) - gold type 4a (NO) + 4b (NC) - (switch PF) - gold type 6a (NO) + 6b (NC) - (switch PF) - gold type Customized, Please contact Sécheron	1	2 3 4 5 6 C	
18	Outlet lenght configuration	Standard Shorter Customized, please contact Sécheron	Z	S C	
19	Low voltage connector	Wago terminal Harting connector	W	H	
20	Working position	Horizontal Side Vertical	H	S V	
21	Device fixation	Fixation outwards bottom Fixation outwards up Fixation inwards	1	2 3	
22	Ambient temperature range	-40°C to +75°C	Z		

Signature:

Name:

Place and date:



Sécheron SA
Rue du Pré-Bouvier 25
1242 Satigny - Geneva
CH-Switzerland

www.secheron.com
Tel: +41 22 739 41 11
Fax: +41 22 739 48 11
ess@secheron.com