

CONTACTORS

Type **BXS09.0X range**
Bidirectional DC contactors

ELECTRIC TRANSPORT VEHICLES / FIXED INSTALLATIONS

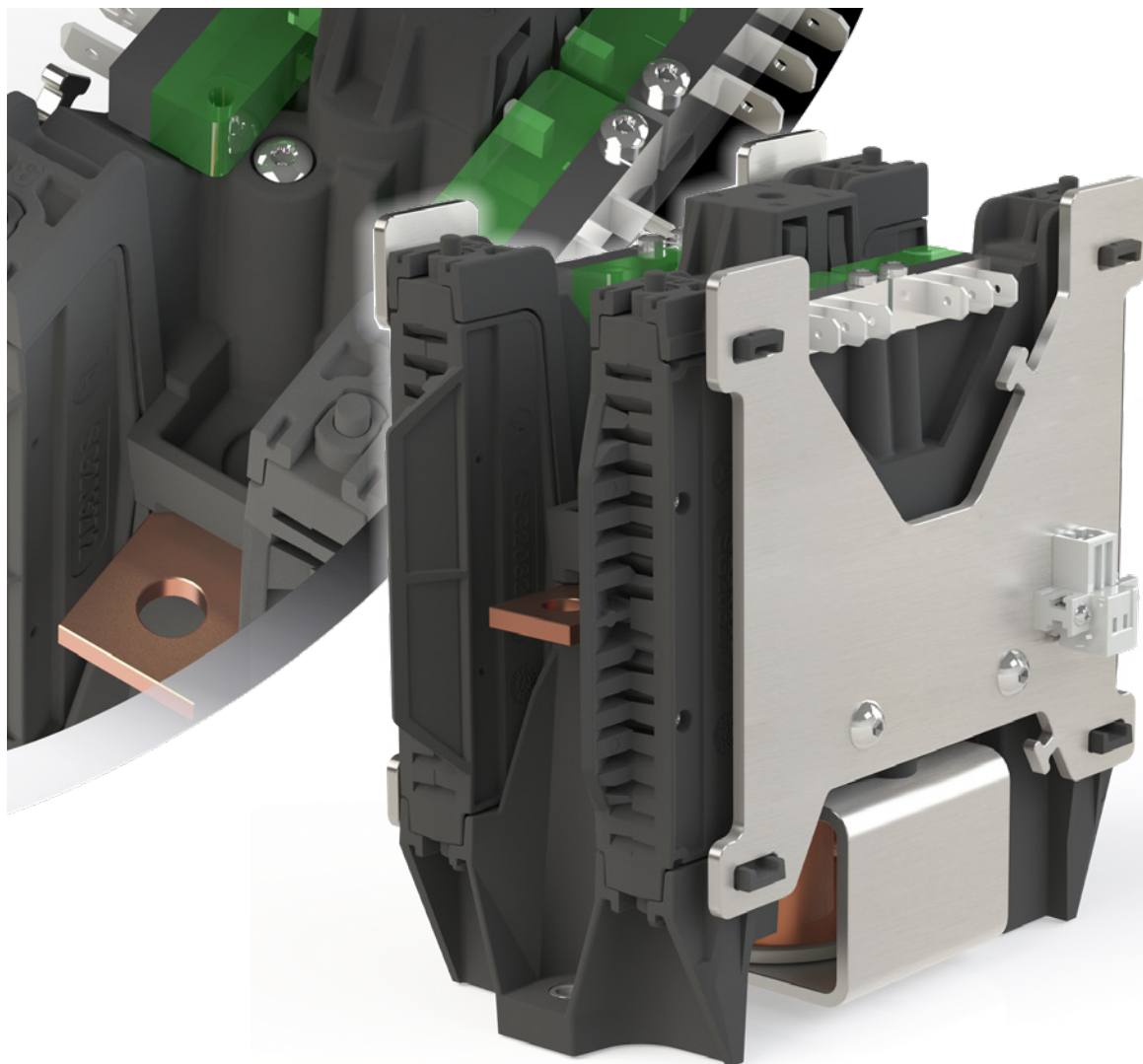

GENERAL INFORMATION

The **BXS09.0X** contactor range has been designed to cover multiple applications on electric transport vehicles and fixed installation up to rated voltage 1,500 V_{DC}. Taking advantages on the tried and tested design of the BMS range, and thanks to its rational and compact layout, the BXS 09.0X allows to reduce to a minimum the overall volume required in the electrical cubicle. Its bidirectional

current breaking capability, the absence of critical current as well as the high value of short time withstand current make this product perfectly suitable for a variety of applications ranging from Rolling Stock to Industrial and Renewables, both for refurbishment and for new installations.

APPLICATIONS, TYPICAL EXAMPLES

Transport Vehicles

- Line contactor for DC vehicles

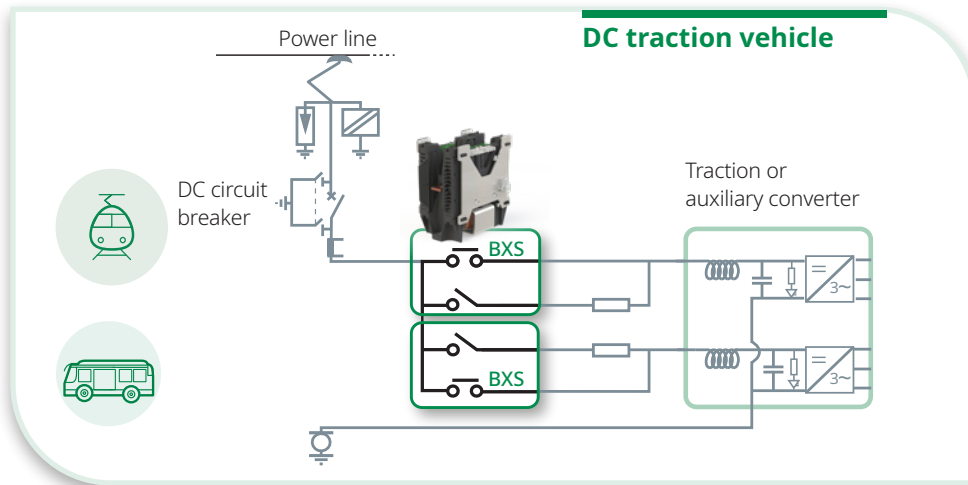

Fixed installation

- Battery Storage Systems, Solar Farms, etc.

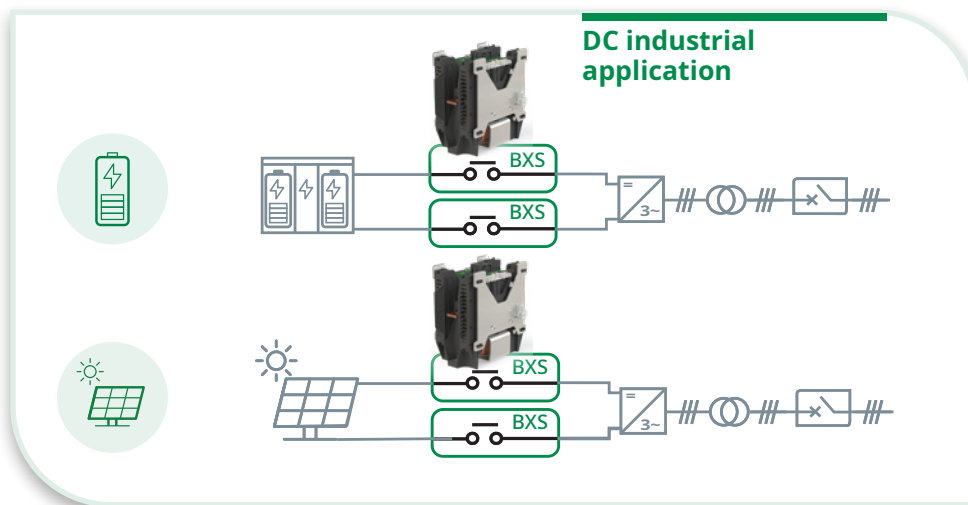

MAIN FEATURES

- Rated Voltage up to 1,500 Vbc
- Conventional free air thermal current 300 and 400 A
- Low voltage control with electronic board
- Suitable for ambient temperature from -40°C to +70°C.
- Reference standards: EN/IEC 60077-1/-2, EN/IEC 61373, EN 45545, EN 50657.

MAIN BENEFITS

- ✓ Bidirectional current breaking.
- ✓ No critical current.
- ✓ High level of Short Time Withstand Current (STWC).
- ✓ High insulation level against pollution PD3A class.
- ✓ Compact size for effective integration.
- ✓ Reduced insulation clearances required for installation.
- ✓ Up to 4 change-over auxiliary contacts.
- ✓ High mechanical and electrical durability.
- ✓ Horizontal or vertical mounting to match tight installation constraint.
- ✓ Low power consumption.
- ✓ Designed for maintenance free operation.

DATA FOR PRODUCT SELECTION

Symbol	Unit	BXS09.0X
MAIN HIGH VOLTAGE CIRCUIT		
Pole quantity		1
Component category		A2
Type of main contacts		NO Normally Open
Current interruption direction		Bidirectional
Rated operational voltage	U_r [V _{DC}]	900 / 1,500
Rated insulation voltage	U_{Nm} [V _{DC}]	1,800
Overvoltage category		OV3
Conventional free air thermal current	I_{th} [A]	300 (T _{amb} =+40°C) 400 (T _{amb} =+40°C)
Rated operational current/operational frequency	I_r [A]	C1 at 150 A / 1 ms @ 900 V _{DC} C1 at 30 A / 15 ms @ 900 V _{DC}
Short-circuit breaking capacity	I_{bc} / I_{mc} [A]	1,000 A 1 ms 1,000 V (1 mH) 500 A 1 ms 1,500 V (3 mH) 70 A 15 ms 1,000 V (220 mH) 40 A 15 ms 1,500 V (565 mH)
Critical current	[A]	No critical current
Rated short-time withstand current	$I_{cw/t}$ [kA]/[ms]	5 / 100
Power-frequency test voltage (50 Hz / 1min)	U_a [kV]	4.6
Rated impulse withstand voltage	U_{Ni} [kV]	10
LOW VOLTAGE CIRCUIT		
Control circuit		
Nominal supply voltage	U_n [V _{DC}]	24; 32; 36; 48; 72; 84; 96 or 110 ⁽¹⁾
Range of voltage		[0.7 - 1.25] U_n
Typical mechanical closing time ⁽²⁾	t_{cc} [ms]	100
Typical mechanical opening time ⁽²⁾	t_{co} [ms]	30
⁽¹⁾ For other voltage, please contact sécheron. ⁽²⁾ At U_n and T _{amb} = +20°C.		
Auxiliary contacts		
Type of contacts		Changeover type S870
Conventional thermal current	I_{th} [A]	10
Utilization category according to EN60947		
- AC-15 230 V _{AC}		1.5 A
- DC-13 60 V _{DC}		0.5 A
- DC-13 24 V _{DC}		2 A
Minimum let-through current at 24 V _{DC} ⁽³⁾	[mA]	≥ 10 (silver contacts)
⁽³⁾ For a dry and clean environment.		
Low voltage interface		
Control circuit		WAGO 734 2-poles cage-clamp connector (standard)
Auxiliary switches		Direct connection (standard) Wired on WAGO 734 12 poles cage-clamp connector (option)
Insulation		
Power-frequency test voltage (50 Hz / 1min)	U_a [kV]	1.5
OPERATING CONDITIONS		
Installation		Indoor
Altitude	[m]	≤ 2,000
Working ambient temperature	T _{amb} [°C]	-40 to +70
Humidity		95% at + 40°C
Pollution degree		PD3A @ U_{Nm} 1,200 V _{DC} / PD3 @ U_{Nm} 1,800 V _{DC}
Minimum mechanical durability	N Operations	≥ 2 millions

PRODUCT INTEGRATION

MAIN DIMENSIONS

HV connections	M5 screws
Earth connections	M4 screw, thread length 8 mm
LV Connections (standard)	Control: WAGO 734 (2 poles) Auxiliary switches: fast-on terminals WAGO 734 (12 poles) as option
Fixing points	M5 screws

Dimensions without tolerances are indicative. All dimensions are in mm.

BXS09.0X

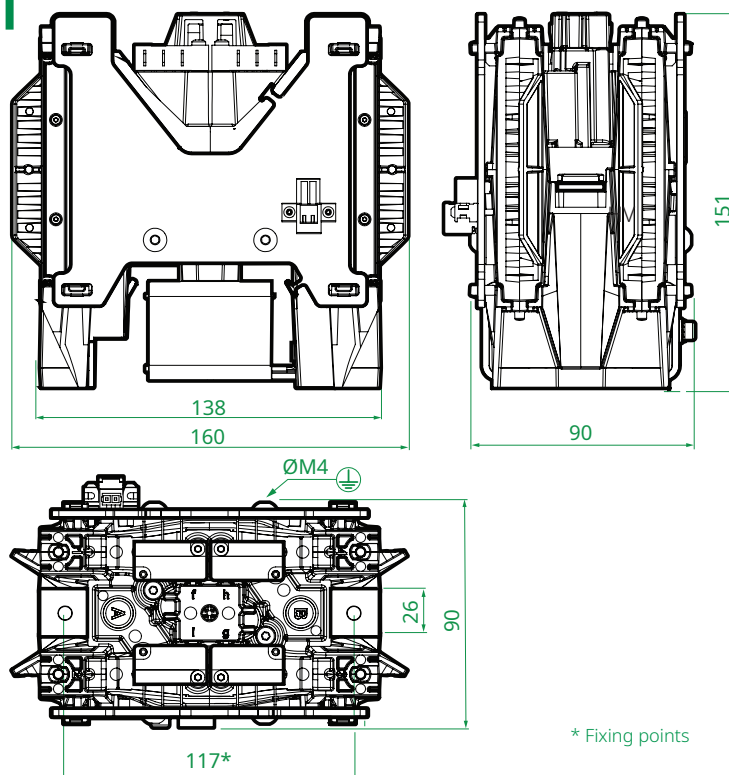

BXS09.0X

1-POLE
Horizontal/vertical installation

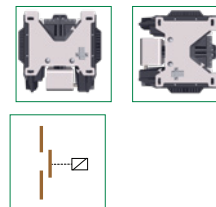

INSULATION DISTANCES AND WEIGHTS

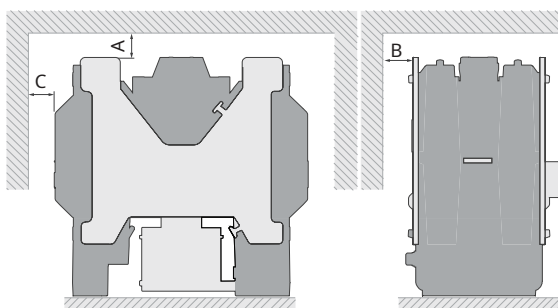

BXS contactors have been homologated according to IEC 60077-2 with the following insulation distances.

contactor type	Insulating distance [mm]			Arc chute removal distance [mm]	Weight: ± 0.5 kg [kg]
	To earthed wall				
	A	B	C		
BXS09.0X	30	25	35	25	1 Pole 2.3 to 2.5*

*Depending of the the version. Please contact Sécheron

AUXILIARY CONTACTS CONFIGURATION

BXS09.0X

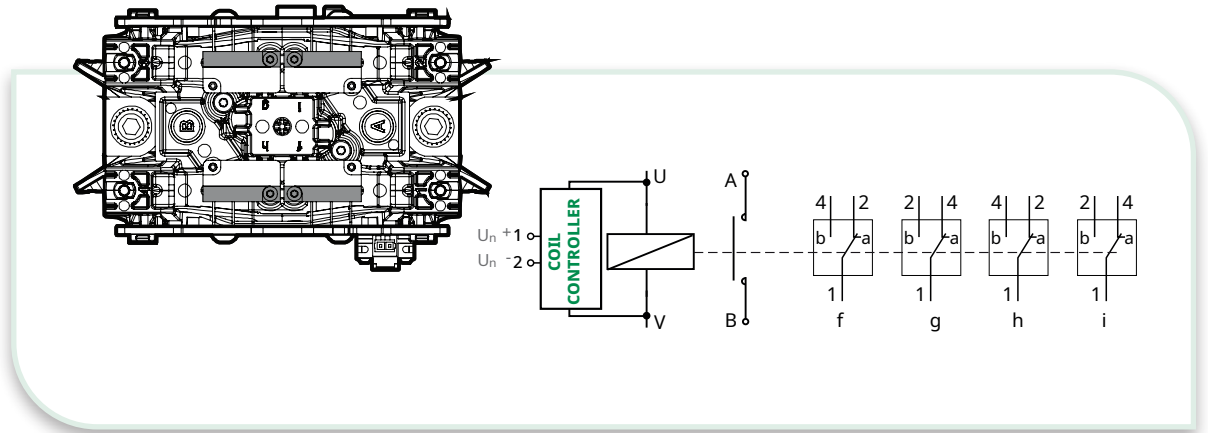

LOW VOLTAGE CONTROL DIAGRAM

CONTACTOR CONFIGURATION ⁽¹⁾		Nominal supply voltage U_n [Vdc]	Closing power (P_c) / Holding power (P_h) [W] / [W]
BXS09.0X horizontal / vertical installation	1 pole	all voltage	≤ 30 / ≤ 10

⁽¹⁾ For details refer to pages 5 & 6.

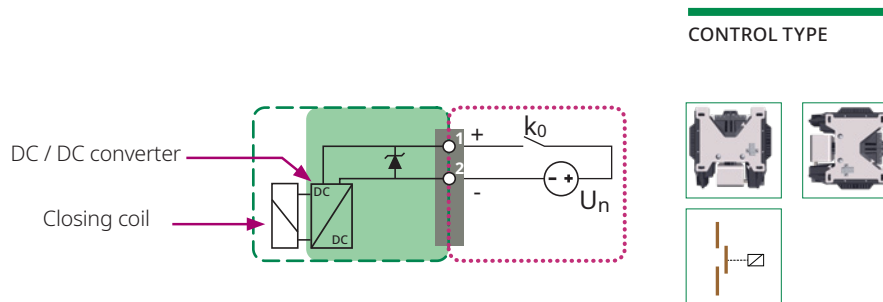

--- Sécheron's scope
 Customer's scope

Low voltage interface
 Coil controller

U_n : DC power supply
 k_0 : Supply relay

SECHERON CONTACTORS RANGE

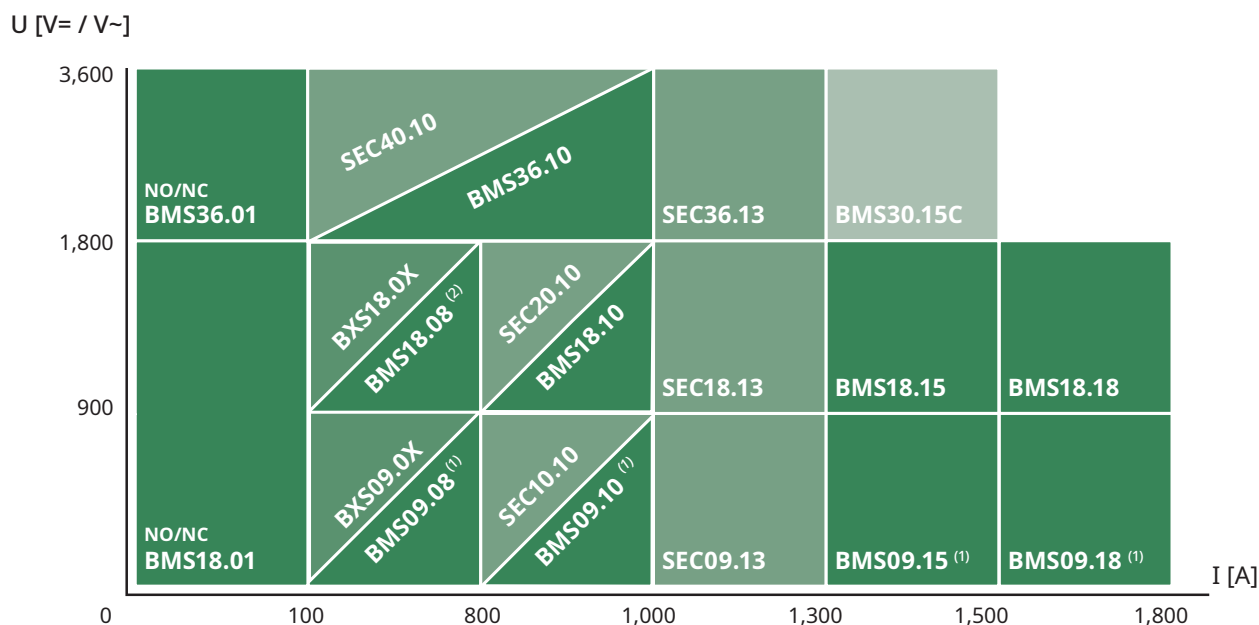

BMS15.002 and **HS** contactors are still available for delivery on repeat order or as spares.

⁽¹⁾ **BMS09...** can be used for rated voltages up to 2,000 V_{AC}

⁽²⁾ A specific version of **BMS18.08** can also be used for rated voltage up to 4,000 V_{AC}

DESIGNATION CODE FOR ORDERING

- Be sure to establish the designation code from the latest version of our brochure by downloading it from the website: www.secheron.com.
- Be careful to write down the complete alphanumerical designation code with 16 characters when placing your order.
- For technical reasons some variants and options indicated in the designation code might not be combined, therefore validate your configuration with Sécheron before ordering.
- For other configurations not described in the brochure, please contact Sécheron.

Example of customer's choice:	BXS	09	03	Z	1	Z	Z	E	A	Z	V	D
Line:	10	11	12	13	14	15	16	17	18	19	20	21

The bold characters of the designation code define the device type.

Note: some combinations may not be possible, therefore validate your configuration with Sécheron before ordering

DESIGNATION CODE

Line	Description	Designation		Customer's
		Standard	Options	choice
10	Product type	BXS	BXS	BXS
11	Rated operational voltage	900/1,500 V	10	10
12	Rated conventional free air thermal current	300 A 400 A	03 04	
13	Spare digit		Z	
14	Number of poles	1 pole	1	
15	Spare digit		Z	
16	Spare digit		Z	
17	Nominal supply voltage	24 V _{DC} 36 V _{DC} 48 V _{DC} 72 V _{DC} 110 V _{DC}	A B C D E	
18	Auxiliary contacts BMS	1 Changeover - (switch PF) - silver type 2 Chanveover - (switch PF) - silver type 3 Chanveover - (switch PF) - silver type 4 Chanveover - (switch PF) - silver type	A	E K O
19	Spare digit		Z	
20	Installation configuration	Horizontal & Vertical	V	
21	Application type	(Direct Current) DC	D	

Signature:

Name:

Place and date:



📍 Sécheron SA
Rue du Pré-Bouvier 25
1242 Satigny - Geneva
CH-Switzerland

www.secheron.com
Tel: +41 22 739 41 11
Fax: +41 22 739 48 11
ess@secheron.com

SA020584BEN_A00-09.24