

HIGH-SPEED DC CIRCUIT BREAKERS FOR FIXED INTALLATIONS (EN/IEC)

Type **UR**

DC TRACTION SUBSTATIONS

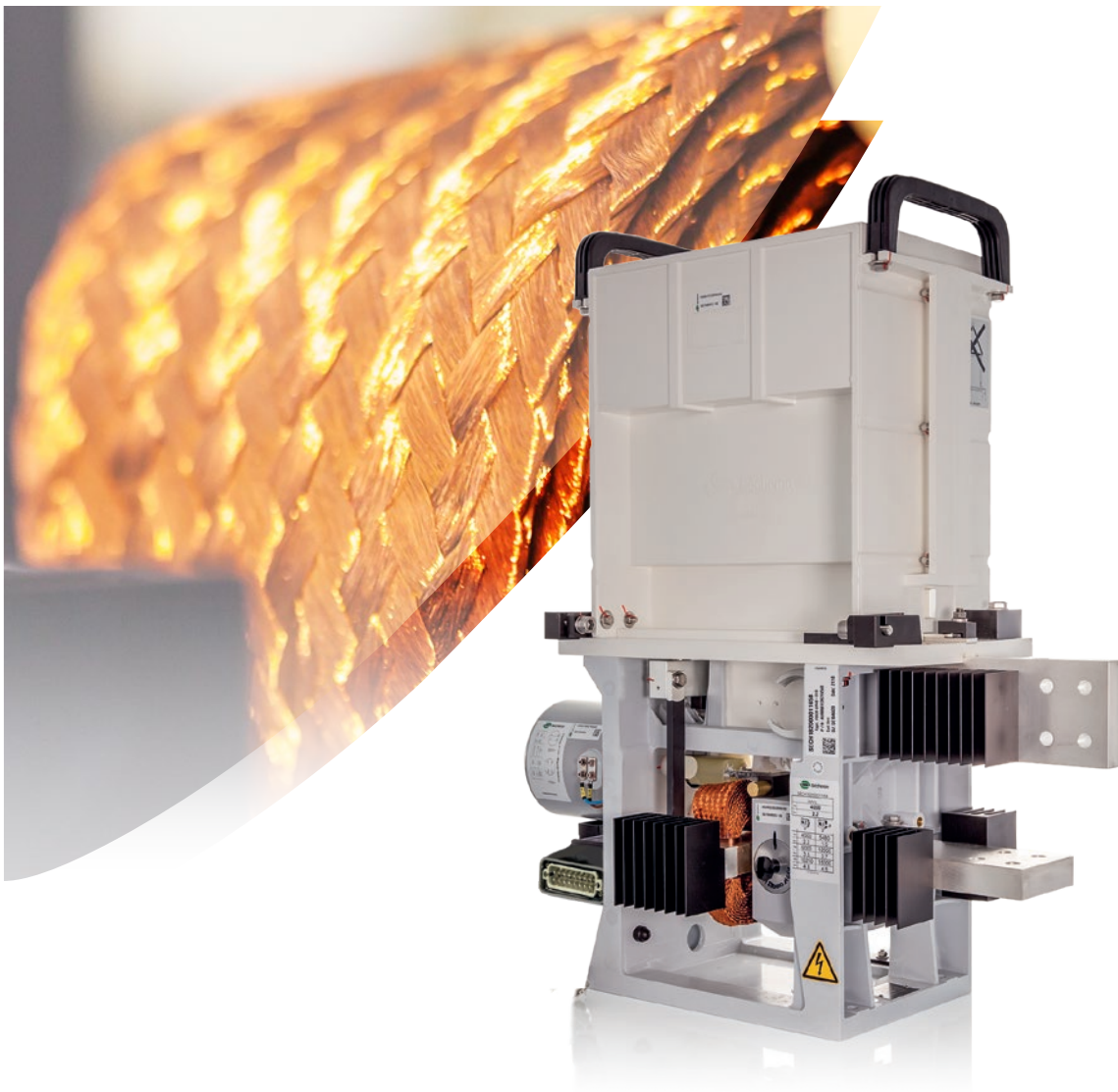

GENERAL INFORMATION

The **UR** range of DC circuit breakers has achieved worldwide acceptance as a well proven design for use in fixed installations. It has been regularly upgraded and adapted to new standard requirements and for different applications over the years, continuously improving the level of performance and functionality.

These have led to an impressive service track record throughout the world for the UR product range. Combining a compact design with a high making and breaking capacity, the UR range, with its low number of parts also guarantees high reliability and low maintenance requirements.

TYPICAL APPLICATION (DC TRACTION POWER SUBSTATION)

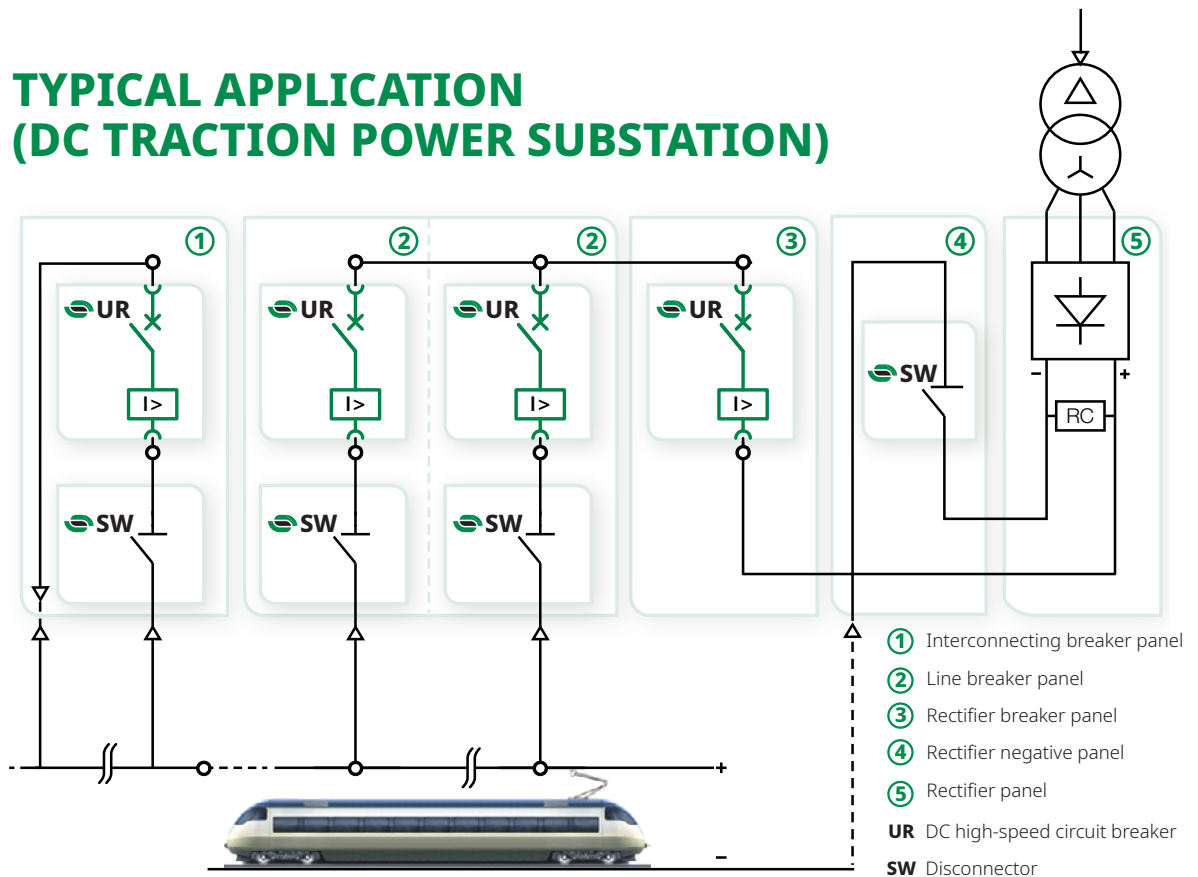

MAIN FEATURES

- Thermal current up to 8,000 A
- Rated voltage 900 V_{DC}, 1,800 V_{DC} and 3,600 V_{DC}
- Indoor installation
- Bidirectional (UR26 to UR80)
- Unidirectional configuration available for UR60 & UR80
- Trip-free direct acting device
- Limited maximum arc voltage
- Electro-magnetic closing with electric or magnetic holding
- Reference standards: EN 50123-1 /-2, IEC 61992-1 /-2
- Insulation material according to EN 45545-2
- Also available according to IEEE (ANSI) C37.14 / C37.16 standards (refer to our specific SG104309BEN brochure)



MAIN BENEFITS

- ✓ Safe with a high insulation level.
- ✓ Very low maintenance requirements with high electrical and mechanical dururances.
- ✓ Simple design with few moving parts resulting in high reliability.
- ✓ High rated short circuit making and breaking capacity.
- ✓ A large number of different options to match the various application requirements.
- ✓ Proven design with worldwide experience and acceptance.

PRODUCT RANGE

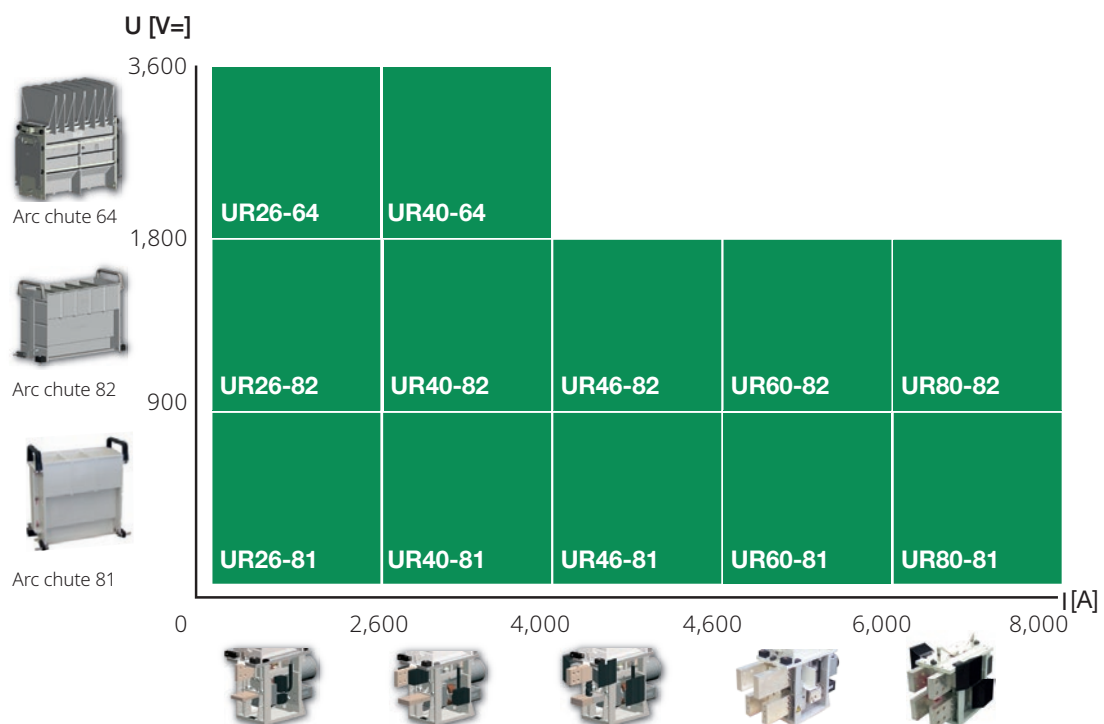

Note: Additionally to the above range, is also available the DC high-speed circuit breaker type UR15 rated 1,500 A and 900 or 1,800 V_{DC}. For more information please contact Sécheron.

BREAKING CURRENT PARAMETERS

THIRD RAIL OR OVERHEAD CATENARY SYSTEM POWERED BY A RECTIFIER

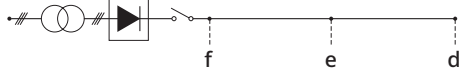

- f : duty f - peak of the short-circuit current
- e : duty e - maximum circuit-energy short-circuit
- d : duty d - distant fault short-circuit.

Note: points f, e and d represent fault conditions along the line at different distances from the rectifier.

CHARACTERISTICS OF THE DUTIES d, e AND f

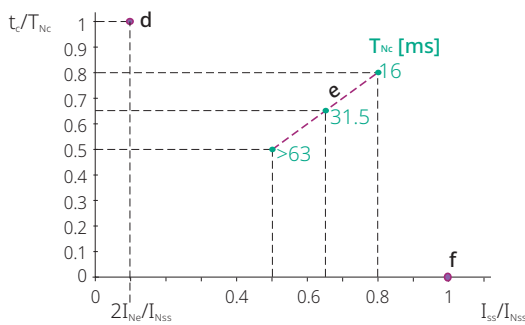

- I_{ss} = Prospective sustained short-circuit current
- I_{Ne} = Rated current
- I_{Nss} = Rated short-circuit current of the circuit breaker
- t_c = Time-constant of the circuit
- t_{Nc} = Rated track time constant of the circuit breaker

BREAKING CURRENT PARAMETERS

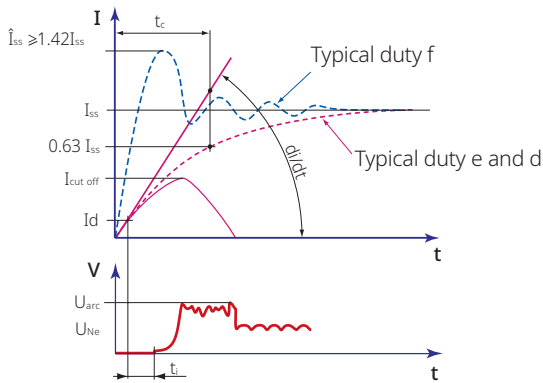

- I_{ss} = Prospective sustained short-circuit current
- \hat{I}_{ss} = Peak of I_{ss}
- di/dt = Initial current rate of rise
- I_d = Setting of maximum current release
- $I_{cut\ off}$ = Cut-off current
- t_c = Time-constant of the circuit
- t_i = Opening time
- U_{arc} = Maximum arc voltage
- U_{Ne} = Rated operational voltage

OPENING TIME t_i

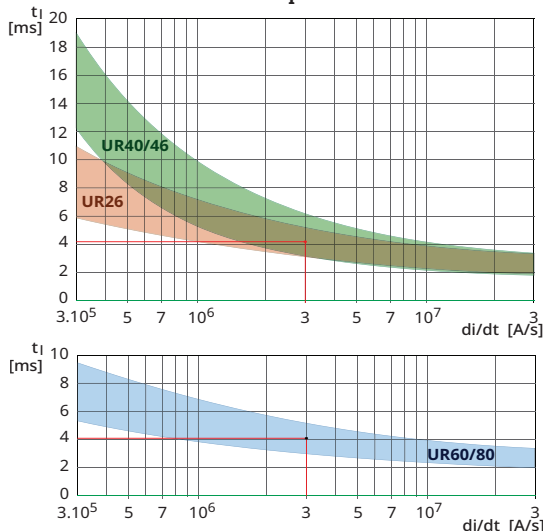

Relationship between opening time t_i and the initial rate of rise of current di/dt for direct instantaneous overcurrent release.

Example for a di/dt of 3×10^6 A/s:

- for UR26: $t_i \sim 4.3$ ms,
- for UR60/80: $t_i \sim 4.1$ ms.

Note: for a shorter opening time on low di/dt , the "indirect release" (shunt trip) option can be used (refer to "Options" section page 12).

DATA FOR PRODUCT SELECTION

	Symbol	Unit	UR26	UR40	UR46	UR60	UR80
MAIN HIGH VOLTAGE CIRCUIT							
Rated voltage							
- arc chute type 81	U_{Ne}	[V _{DC}]	900	900	900	900	900
- arc chute type 82			1,800	1,800	1,800	1,800	1,800
- arc chute type 64			3,600	3,600	-	-	-
Rated insulation voltage							
- arc chute type 81	U_{Nm}	[V _{DC}]	3,000	3,000	3,000	3,000	3,000
- arc chute type 82			3,000	3,000	3,000	3,000	3,000
- arc chute type 64			4,800	4,800	-	-	-
Conventional free air thermal current ⁽¹⁾	I_{th}	[A]	2,600	4,000	4,600	6,000	8,000
Rated short-circuit making & breaking capacity							
- arc chute type 81 at U_{Ne} 900 V _{DC}	I_{Nss}/T_{Nc}	[kA]/[ms]	125/100	125/100	125/100	125/100	125/100
- arc chute type 82 at U_{Ne} 1,800 V _{DC}			80/31.5	80/31.5	80/31.5	80/31.5 ⁽²⁾	80/31.5
- arc chute type 64 at U_{Ne} 3,600 V _{DC}			40/31.5	50/31.5	-	-	-
Peak & rated short-time withstand current (250 ms) ⁽³⁾	\hat{I}_{Ncw}/I_{Ncw}	[kA]/[kA]	-	-	-	75/50	75/50
Direct overcurrent instantaneous release							
- (bidirectional) ⁽⁴⁾		[kA]	1.4-8.0	2-15	2-15	6-18	8-24
- (unidirectional)		[kA]	-	-	-	6 or 4-10	6 or 4-10
Power-frequency withstand voltage (50 Hz/1 min) ⁽⁵⁾							
- arc chute type 81	U_a	[kV]	12	12	12	12	12
- arc chute type 82			12	12	12	12	12
- arc chute type 64			15	15 ⁽⁶⁾	-	-	-
Rated impulse withstand voltage							
- arc chute type 81	U_{Ni}	[kV _{DC}]	20	20	20	15	15
- arc chute type 82			20	20	20	20	20
- arc chute type 64			30	30 ⁽⁶⁾	-	-	-
Maximum arc voltage							
- arc chute type 81	U_{arc}	[V _{DC}]	≤ 2,500	≤ 2,500	≤ 2,500	≤ 2,500	≤ 2,500
- arc chute type 82			≤ 4,000	≤ 4,000	≤ 4,000	≤ 4,000	≤ 4,000
- arc chute type 64			≤ 8,000	≤ 8,000	-	-	-

⁽¹⁾ At $T_{amb} = +40^\circ\text{C}$ and tested with high voltage connections according to standards EN 50123 and IEC 61992. ⁽²⁾ Also tested at 100 kA (142 kA_{pb}). ⁽³⁾ For unidirectional version. For other configurations with higher value, please contact Sécheron. ⁽⁴⁾ For range selection, refer to the table page 6. ⁽⁵⁾ Values applicable for factory tests on serial products. ⁽⁶⁾ For higher values, please contact Sécheron.

LOW VOLTAGE CIRCUIT

Control circuit

Nominal supply voltage	U_n ⁽⁷⁾	[V _{DC}]	24, 48, 60, 64, 110, 125, 200, 220			
Range of voltage			[0.7 - 1.25] U_n		[0.8 - 1.1] U_n	
Maximum closing power ⁽⁷⁾⁽⁸⁾		[W]/[s]	1,300/1 (E) 1,300/1 (M) ⁽⁹⁾		3,200/1 (E) 2,600/1 (M)	
Holding power		[W]	2.3 (E) 0 (M)		15 (E) 0 (M)	
Opening power		[W]/[s]	25/1 (M)		700/1 (M)	
Mechanical opening time on opening order ⁽¹⁰⁾	t_o	[ms]	15 - 30 (E) 5 - 75 (M)		15 - 30 (E) 75 (M)	
Mechanical closing time ⁽⁸⁾⁽¹⁰⁾	t_c	[ms]	~ 150 (E) (M)		~ 150 (E) (M)	

⁽⁷⁾ For available voltage per type of breaker refer to page 10 and 11. ⁽⁸⁾ At U_n and $T_{amb} = +20^\circ\text{C}$ and for standard version of closing device. ⁽⁹⁾ (E) E-type: Electric holding | (M) M-type: Magnetic holding. ⁽¹⁰⁾ Starting when the signal is received by the coil.

Auxiliary contacts

Type of contacts (refer to definition on page 12)			Potential free (PF) or change-over (CO)			
Number of auxiliary contacts			5a + 5b			
Rated voltage		[V _{DC}]	24 to 220			
Conventional thermal current	I_{th}	[A]	10			
Switching categories according to EN 60947 (silver contacts)		[A]	AC-15 230 V _{AC} 1.0 A DC-13 110 V _{DC} 0.5 A			
Minimum let-through current at 24 V _{DC} ⁽¹¹⁾ (silver contacts)		[mA]	≥ 10			

⁽¹¹⁾ For a dry and clean environment.

Low voltage interface

Type of connection ⁽¹²⁾			Harting type Han® 32 EE			
------------------------------------	--	--	-------------------------	--	--	--

⁽¹²⁾ For mobile connector information refer to page 12.

OPERATING CONDITIONS

Installation			Indoor				
Altitude		[m]	≤ 2,000 ⁽¹³⁾				
Working ambient temperature ⁽¹⁴⁾	T_{amb}	[°C]	- 25 to + 40				
Humidity			according to IEC 62498-2/EN 50125-2				
Pollution degree			PD3				
Minimum mechanical durability	N Operations		4x50,000	8x25,000	8x25,000	4x20,000	4x20,000

⁽¹³⁾ For altitude >2,000 m, please contact Sécheron. ⁽¹⁴⁾ For ambient temperature outside of the range, please contact Sécheron.

DIRECT OVERCURRENT RELEASE SELECTION

AVAILABLE TRIPPING DEVICES

Available setting ranges (in kA) with their corresponding codification

UR26	UR40	UR46	UR60	UR80	type	Designation code ⁽¹⁾	
						Standard	Options
1.4 - 2.7	-	-	-	-	DV1	A	
2.0 - 5.0	2.0 - 5.0	2.0 - 5.0	-	-	DV2		B
2.0 - 5.0	2.0 - 5.0	2.0 - 5.0	-	-	DE1		C
2.0 - 8.0	2.0 - 8.0	2.0 - 8.0	-	-	DS1	D	
4.0 - 8.0	4.0 - 8.0	4.0 - 8.0	-	-	DE2		E
-	4.0 - 15.0	4.0 - 15.0	-	-	DS2	F	
-	4.0 - 10.0	4.0 - 10.0	-	-	DV3		G
-	6.0 - 10.0	6.0 - 10.0	-	-	DE3		H
-	9.0 - 15.0	9.0 - 15.0	-	-	DE4		I
-	-	-	6.0 - 10.0	-		J	
-	-	-	10.0 - 14.0	-		K	
-	-	-	14.0 - 18.0	-		L	
-	-	-	-	8.0 - 14.0		N	
-	-	-	-	14.0 - 18.0		O	
-	-	-	-	18.0 - 24.0		P	
-	-	-	6.0 ⁽²⁾	6.0 ⁽²⁾			U
-	-	-	6.0 ⁽³⁾	6.0 ⁽³⁾		W	
-	-	-	4.0 - 10.0 ⁽²⁾	4.0 - 10.0 ⁽²⁾			X
-	-	-	4.0 - 10.0 ⁽³⁾	4.0 - 10.0 ⁽³⁾			Y

⁽¹⁾ For selection page 16.

⁽²⁾ Unidirectional overcurrent release. Tripping direction A → B. $\hat{I}_{New}/I_{New} = 75/50$ kA.

⁽³⁾ Unidirectional overcurrent release. Tripping direction B → A. $\hat{I}_{New}/I_{New} = 75/50$ kA.

AVAILABLE TRIPPING DEVICES

UR26/40/46

Standard tripping device

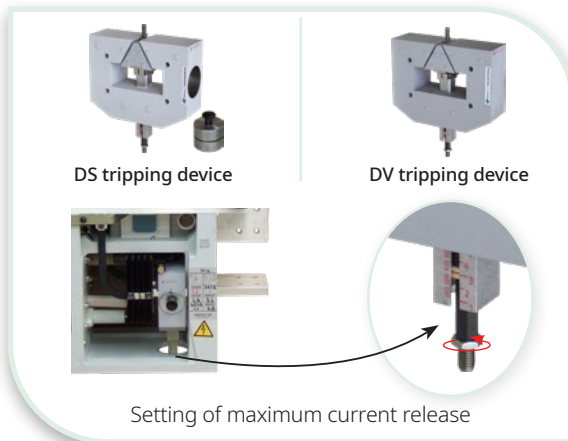

UR60/80

Standard tripping device

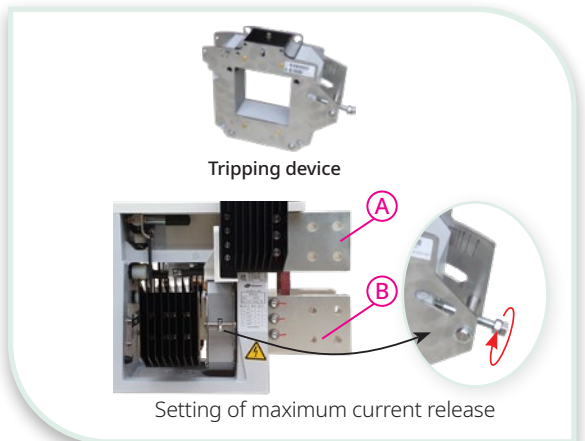

Optional DE type tripping device

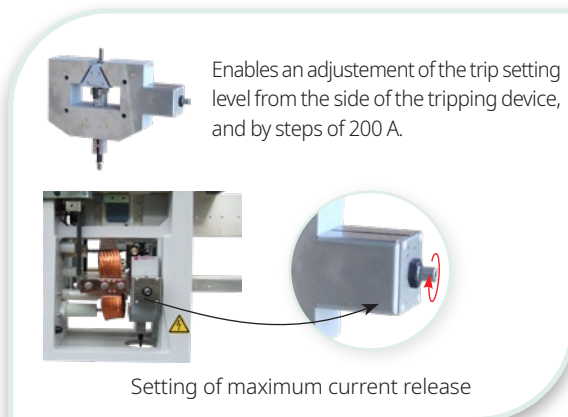

Specific configurations for rectifier circuit breakers

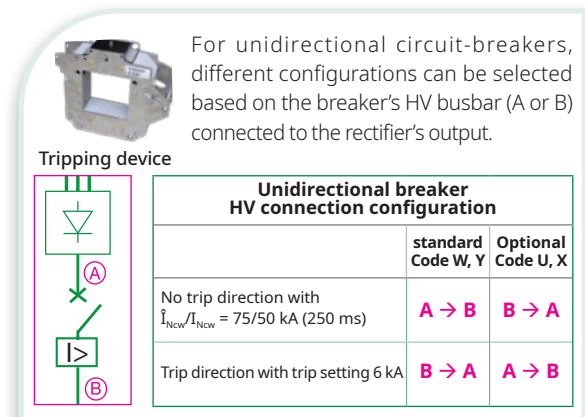

INFORMATION FOR PRODUCT INTEGRATION

MAIN DIMENSIONS FOR UR26/40/46

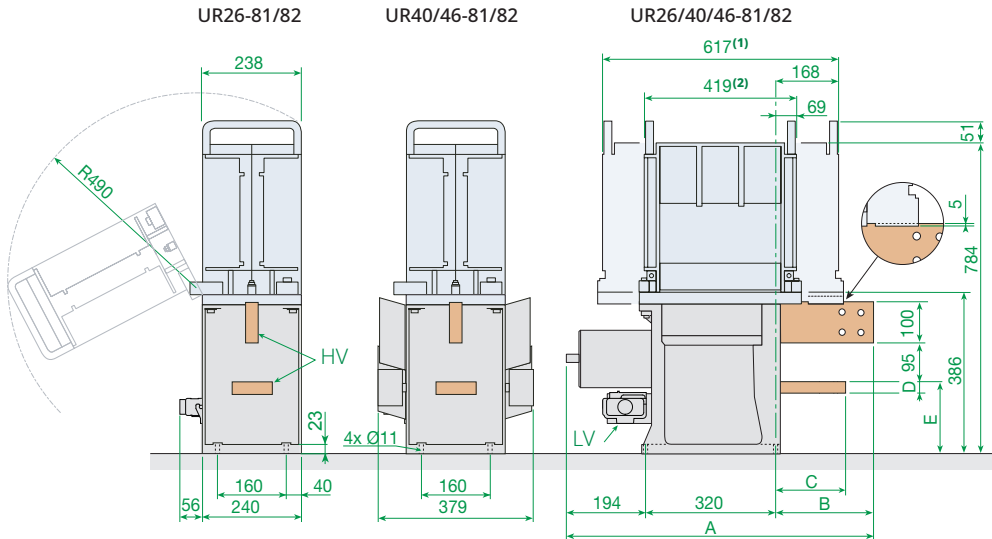

Dimensions without tolerances are indicative. All dimensions are in mm. The maximum allowed flatness deviation of the support frame is 0.5 mm.

- (1) Arc chute 82
- (2) Arc chute 81

HV connections for UR26/40/46

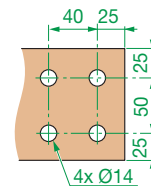
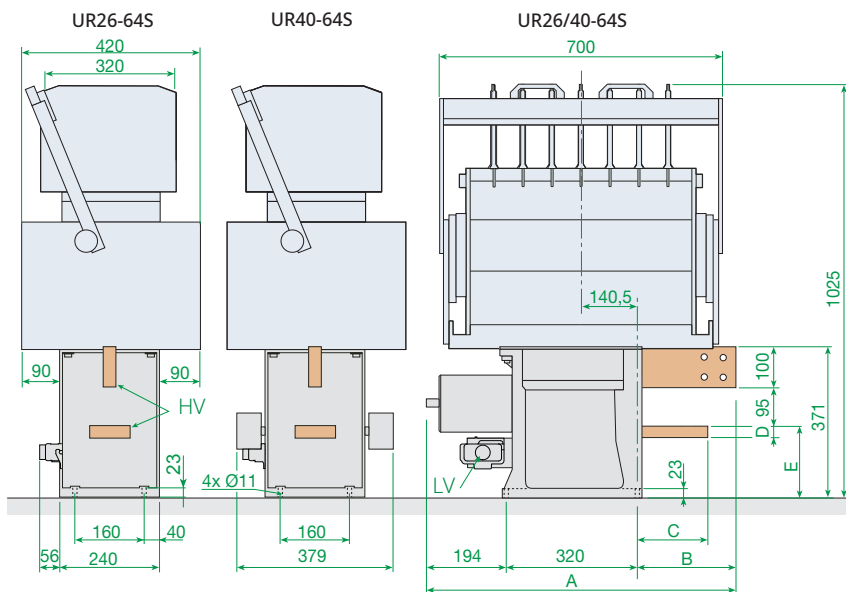

Dimensions [mm]	UR26	UR40	UR46
(A)	645	760	760
(B)	131	246	246
(C)	131	176	176
(D)	20	30	40
(E)	176	176	177

MAIN DIMENSIONS FOR UR60/80

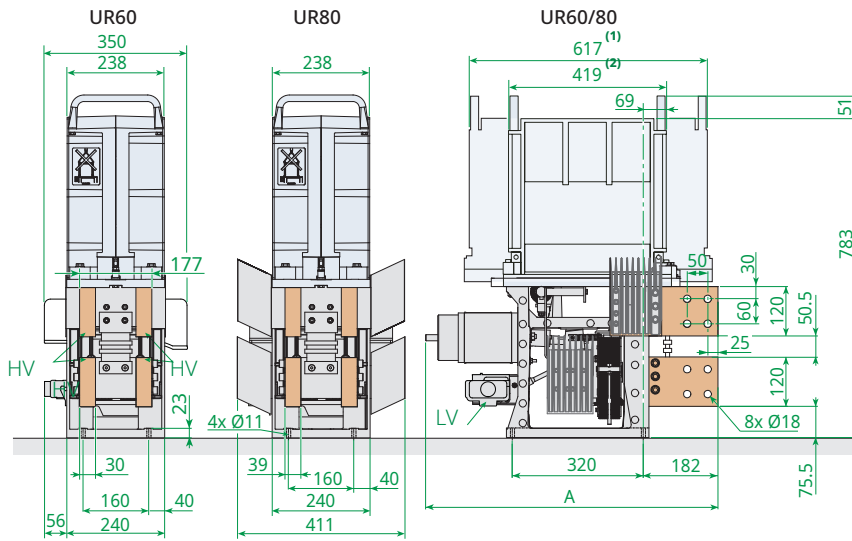

Dimension A [mm]	
Standard closing device ⁽³⁾	
Electric holding	718
Magnetic holding	756
Specific closing device ⁽⁴⁾	
Electric holding	748
Magnetic holding	748

⁽¹⁾ Arc chute 82

⁽²⁾ Arc chute 81

⁽³⁾ All breaker configurations excepted optional configuration of unidirectional breaker.

⁽⁴⁾ Optional configuration of unidirectional breaker

WEIGHTS

	Weights ⁽¹⁾ [kg] ± 5%				
	UR26	UR40	UR46	UR60	UR80
With arc chute 81	77	98	110	139	150
With arc chute 82	87	108	120	149	160
With arc chute 64	133	154			

⁽¹⁾ Weights for standard circuit breaker without any option.

INSULATION DISTANCES FOR UR26/40/46/60/80

UR..81/82S

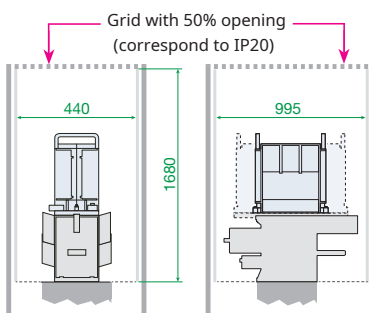

Correspond to cubicle width 500 mm

UR..64S

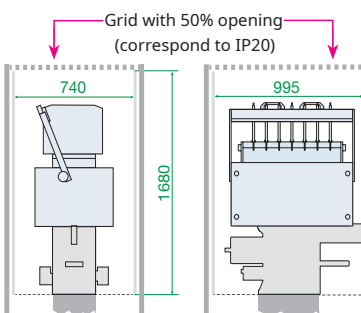

Correspond to cubicle width 800 mm

The DC circuit breakers have been homologated according to EN 50123-2/ IEC 61992-2 in cubicle's configurations with insulation panels on the area where dimensions are indicated in the below's representation, and for short-circuit conditions I_{nss}/T_{nc} and duty f, e, d, as defined page 5.

For particular cubicle configuration and short-circuit conditions, please contact Sécheron.

ARC CHUTE INSTALLATION

ARC CHUTE 81 AND 82

Opening to LV connector side

UR26/40/46 (arc chutes 81/82) -
UR60/80 (arc chute 82)

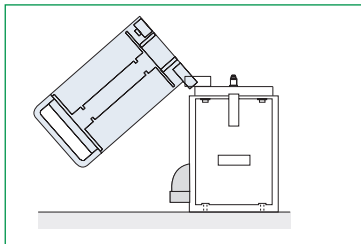

Opening to LV connector opposite side

UR26/40/46 (arc chutes 81/82)
UR60/80 (arc chute 82)

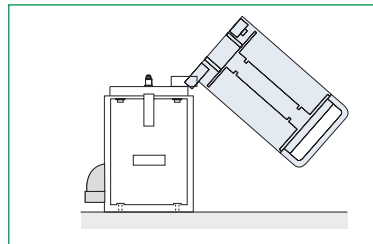

Vertical removal

UR60/80 (arc chute 81)

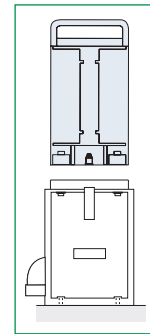

Designation code for order form (arc chute 81/82 installation)

Circuit breaker	Arc chute type	Arc chute installation	Codification	
			standard	option
UR26/40/46	81/82	Opening to LV connector side	1	
		Opening to LV connector opposite side		7
UR60/80	81	Vertical removal	8	
	82	Opening to LV connector side	1	
		Opening to LV connector opposite side		7

ARC CHUTE 64 (ONLY FOR UR26/40)

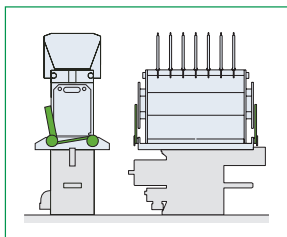

SE
it includes two arc chute locking levers.

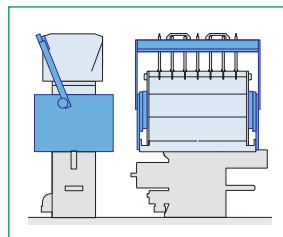

S-CC
it includes an arc chute lifting lever located on connector side.

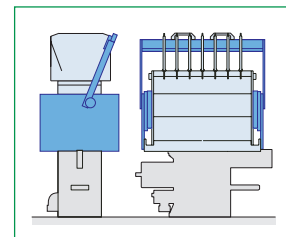

S-OC
it includes an arc chute lifting lever located on the connector opposite side.

Legend

- Arc chute locking levers
- Arc chute lifting lever

Designation code for order form (arc chute 64 installation)

Arc chute type	Circuit breaker	Arc chute installation	Codification	
			standard	option
64	UR26/40	SE	2	
		S-CC		5
		S-OC		6

LOW VOLTAGE CONTROL DIAGRAM

The **UR** range is equipped with a solenoid coil to perform the usual closing and opening operations.
Two different types of closing devices are available: with electric holding (E-type) or with magnetic holding (M-type).

ELECTRIC HOLDING E-TYPE

- The circuit breaker remains closed with a **reduced "holding" current**. To open the circuit breaker the holding current is cut-off.
- With **E-type** closing device, the circuit breaker cannot remain closed if the low voltage supply is lost.

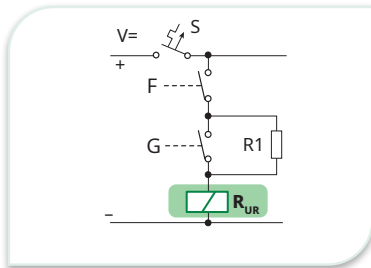

F, G : control contacts
R1 : holding resistor
S : automatic circuit breaker

Customer scope
Sécheron scope

MAGNETIC HOLDING M-TYPE

- The circuit breaker remains closed **without any control current**. To open the circuit breaker it is necessary to reverse the polarity of the current flowing through the closing coil.
- With the **M-type** closing device, the circuit breaker remains closed when the low voltage supply is lost. It requires the control voltage to be present to open.

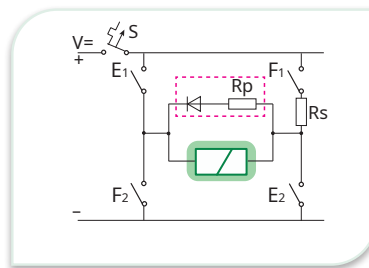

E, F : control contacts
Rs : serial resistor
Rp : parallel resistor
S : automatic circuit breaker

Customer scope
Sécheron scope
Only for UR26 to UR46

Note:

- For technical data related to closing devices and needed to design the circuit breaker's control circuit, refer to the instruction manual of the selected product.
- For M-type closing device, the circuit breaker's direct tripping function remains always active even if the low voltage supply is lost.
- The duration of the closing pulse (E-type & M-type) as well as the opening pulse (M-type) should be 0.5 - 1 s.

TYPICAL VALUE FOR CLOSING COILS - UR26/40/46

	Coil characteristics													
	Closing pulse 0.5 to 1s				holding E-type			opening pulse M-type 0,5 to 1s						
U _n	I _{nom}	I _{min} E	I _{min} M	I _{max}	R1	I _{nom}	I _{min}	I _{max}	Rs	Rp	I _{nom}	I _{min}	I _{max}	
[V _{DC}]	[A]	[A]	[A]	[A]	[Ω]	[A]	[A]	[A]	[Ω]	[Ω]	[A]	[A]	[A]	
24	41.7	22.5	25	70.9	11.4	2.0	1.4	2.5	2.4	1.3	6.1	3.8	8.5	
48	20.9	11.3	12.5	35.4	45.7	1.0	0.7	1.3	9.4	5.4	3.1	1.9	4.3	
64	17.6	9.5	10.6	29.9	79.4	0.8	0.5	1.0	17.2	9.0	2.3	1.5	3.2	
110	11.7	6.3	7.0	19.9	210	0.5	0.4	0.6	40	20	1.6	1.0	2.3	
125	10.5	5.6	6.3	17.8	272	0.4	0.3	0.6	52	26	1.4	0.9	2.0	
220	5.9	3.2	3.5	9.9	840	0.3	0.2	0.3	160	80	0.8	0.5	1.1	

The breaker can also be controlled with a rectified AC control voltage.

TYPICAL VALUE FOR CLOSING COILS - UR60/80

Coil characteristics															
U _n [V _{DC}]	E-type								M-type						
	Closing pulse 0.5 to 1s			holding					Closing pulse 0.5 to 1s			opening pulse			
	I _{nom}	I _{min}	E	I _{max}	R1 _{nom} ⁽²⁾	I _{nom} ⁽²⁾	I _{min} ⁽²⁾	I _{max} ⁽²⁾	I _{nom}	I _{min}	M	I _{max}	Rs _{nom}	I _{nom}	I _{min}
[A]	[A]	[A]	[A]	[Ω]	[A]	[A]	[A]	[A]	[A]	[A]	[A]	[Ω]	[A]	[A]	[A]
48	63.9	40.8	85	12	3.8	3.1	4.2	47.1	30.1	62.8	2.7	12.6	10.3	14.2	
60	53.6	34.2	71.2	18	3.2	2.5	3.4	38.1	24.3	50.7	3.9	10.2	8.8	12.1	
110	25.0	16.6	33.2	56	1.8	1.5	2.0	21.3	13.5	28.3	15	5.4	4.1	6.3	
125	22.5	14.9	29.9	75	1.6	1.3	1.7	18.4	11.7	24.5	18	5.0	3.8	5.8	
200 ⁽¹⁾	17.2	11.4	22.9	180	1.1	0.9	1.1	—	—	—	—	—	—	—	
220	12.4	8.2	16.4	220	0.9	0.8	1.0	11.6	7.4	15.5	56	2.9	2.2	3.3	

⁽¹⁾ Rectified 230 V_{AC}
⁽²⁾ With selected economy resistor

The breaker can also be controlled with a rectified AC control voltage

LOW VOLTAGE CONTROL DIAGRAM FOR HARTING TYPE HAN®32 EE CONNECTOR (STANDARD)

The following wiring schemes represent the low voltage connector pins assignment in function of the selected connectors and the configuration chosen for standard or optional functions. They are valid for all control voltages except 24 V_{DC}. For 24 V_{DC} control scheme, please contact Sécheron.

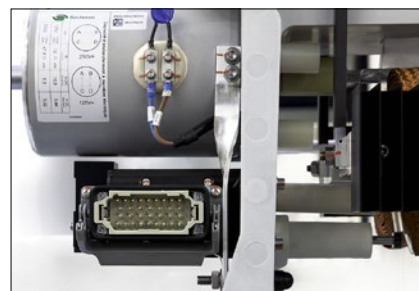

Harting type HAN® 32 EE
(Standard)

Only the pins related to your selected configuration page 16 will be wired according to the below's pin assignment. The connector will be delivered with all 32 pins even if not all wired.

Legend

	Circuit breaker main contact
	Direct overcurrent release
	Low voltage connector interface (male pin)
	1a+1b - Switch PF
	1a+1b - Switch CO
	Indirect overcurrent release
	Circuit breaker closing coil
	Wear indicator switch (option)
	Overcurrent release detector switch (option)

AUXILIARY CONTACTS (SWITCH PF)

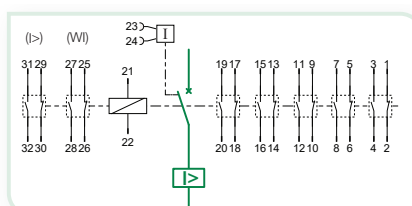

AUXILIARY CONTACTS (SWITCH CO)

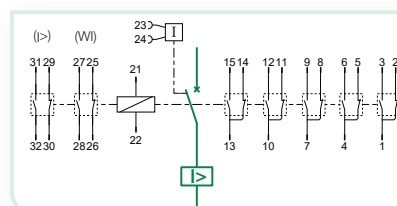

Note:



- Low voltage connectors are delivered with all pins mounted, even if not all wired.

- Indirect release coils BIM6 & BIM8 are connected to a low voltage connector while BIM5 & BIM7 are connected to a terminal block (refer to page 14).

OPTIONS

(SUBJECT TO ADDITIONAL COSTS)

MOBILE CONNECTOR - UR26/40/46/60/80

Auxiliary switches			Control voltage	Fixed connector type	Mobile connector (without cable)				
Device	Number	Type			Number of pin (delivered with connector)		Cable gland	Sécheron's number	Connector
					Size 2.5 mm ²	Size 1.5 mm ²			
UR26 (without ECO-Drive)	5a+5b	PF	24,36, 48, 64, 72, 110 V _{DC}	Harting HAN® 32 EE	4	28	M32	SG104063R10800	
UR26/40/46 (with ECO-Drive) with options (W) or (I>) and □	5a+5b	PF	24 V _{DC}	Harting HAN® 32 EE	4	28	M32		
UR26/40/46 (with or without ECO-Drive) with options (W) or (I>) and □	5a+5b	PF	48, 64, 110, 125, 200, 220 V _{DC}	Harting HAN® 32 EE	2	30	M32	SG104063R10100	
UR60/80 (without ECO-Drive)	5a + 5b	PF	48, 64, 110, 125, 200, 220 V _{DC}	Harting HAN® 32 EE	2	30	M32	SG104063R10100	

ECO-DRIVE INTEGRATED CONTROL MODULE UR26/40/46

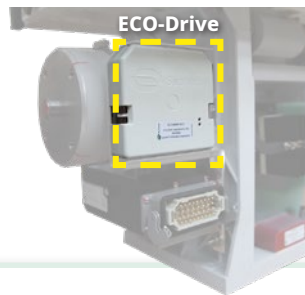

ECO-Drive is a compact control module integrated with UR circuit breakers, to manage closing-holding sequences with electric control. ECO-Drive is set on the UR breaker's closing device.

MAIN BENEFITS

- ✓ No need of additional hardware to control the breaker.
- ✓ Compact integration.
- ✓ Reduction of overall installation costs.
- ✓ Reduction of operational costs with lower power consumption.
- ✓ Reduction of the risks to damage the closing coil.
- ✓ Full compliance with EN 50121-3-2 standards for EMC
- ✓ Full compliance with EN 50155 § 5.1.1.2 class S2 (short interruption of voltage supply).
- ✓ Full compliance with EN 50155 § 5.1.3 class C1 (supply change over).

- Available for UR26/40/46
- Available for closing device with E-type holding

LOW VOLTAGE WIRING DIAGRAM HARTING CONNECTOR

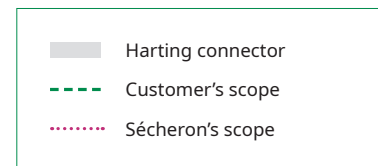
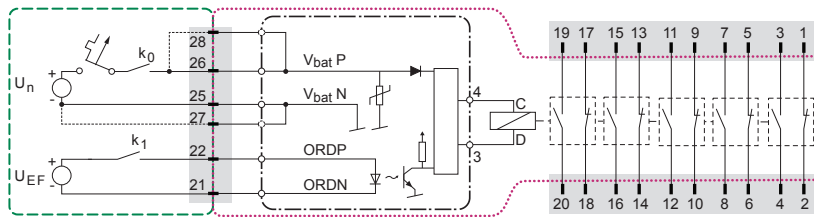

Note: Certain option combination might not be compatible. Please check with Sécheron.

TECHNICAL DATA

Control circuit			
Nominal supply voltage ⁽¹⁾	U_N	[V _{DC}]	24, 48, 60, 110
Nominal control voltage ⁽¹⁾	U_{EF}	[V _{DC}]	[24 - 110]
Range of voltage			[0.7 - 1.25] U_n
Idle (standby) power		[W]	< 1.6
Nominal closing power ⁽²⁾	P_c	[W]/[s]	1,300/0.5
Nominal holding power ⁽²⁾		[W]	< 8
Nominal opening power ⁽²⁾		[W]	< 1.6
Mechanical opening time on opening order ⁽³⁾		[ms]	15-30
Mechanical closing time on closing order ⁽²⁾⁽³⁾	T_c	[ms]	~150

- ⁽¹⁾ Control voltage U_{EF} and supply voltage U_n can be different
- ⁽²⁾ At U_n and $T_{amb} = +20^\circ\text{C}$
- ⁽³⁾ Starting when the signal is received by the coil

POSITION INDICATOR - UR26/40/46/60/80

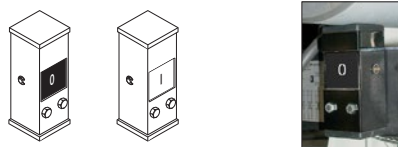

A mechanical position indicator actuated through a rod linked to the circuit breaker moving contact gives the position of the breaker: 0 = OPEN while I = CLOSED

BIM INDIRECT RELEASE (SHUNT TRIP) WITH INTEGRATED MANUAL RELEASE

		Opening time	Control mode
UR26/40/46	BIM5	4 - 6 ms	CID-3 ⁽¹⁾
	BIM6	12 - 19 ms	Direct battery 77-140 V _{DC}
UR60/80	BIM7	4 - 6 ms	CID-3 ⁽¹⁾
	BIM8	12 - 19 ms	Direct battery 77-140 V _{DC}

The indirect release enables to shorten the opening time when required by specific application. The choice of the relevant type has to be validated by Sécheron prior quoting. This device can also be manually activated.

- ⁽¹⁾ Not included in the DC circuit breaker - To be ordered separately

/// BIM5 & BIM6 - UR26/40/46

The terminal block allows the connection between 2.5 mm² cables from the BIM5 and 2.5 mm² cables from the battery and 6 mm² cables from the CID-3. BIM6 is directly connected to the low voltage connector.

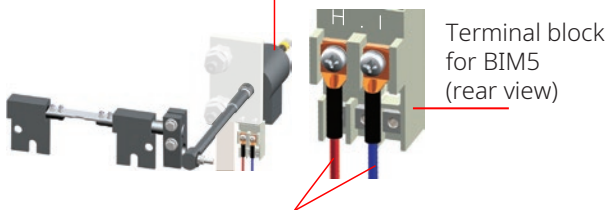
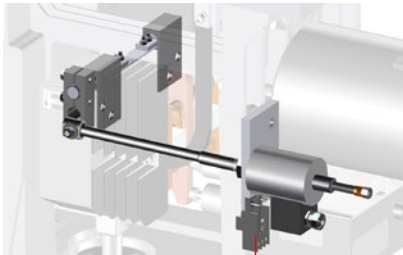

Terminal block for BIM5 (rear view)

Cables from CID-3 or from battery (customer's scope)

/// BIM7 & BIM8 - UR60/80

The terminal block allows the connection between 2.5 mm² cables from the BIM7 and 2.5 mm² cables from the battery and 6 mm² cables from the CID-3. BIM8 is directly connected to the low voltage connector.

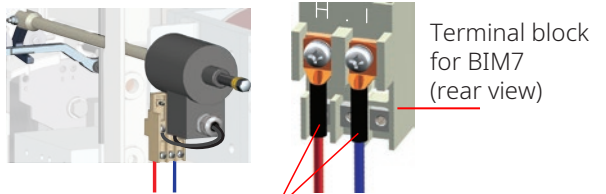
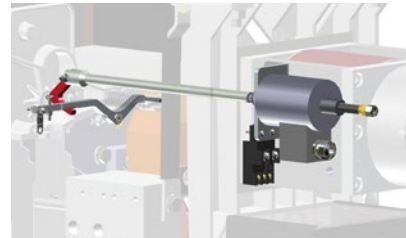

Terminal block for BIM7 (rear view)

Cables from CID-3 or from battery (customer's scope)

MANUAL RELEASE

Manual releases are safety devices designed to guarantee that the breaker is in OPEN position so as to access the breaker's panel -e.g. for maintenance. The vertical release is automatically actuated while

withdrawing from the panel the trolley on which the breaker is installed. The horizontal release must be manually actuated from the front side of the panel door before opening it.

/// UR26/40/46

vertical release



actuation

horizontal release

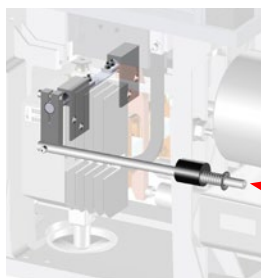

actuation

/// UR60/80

vertical release



actuation

horizontal release

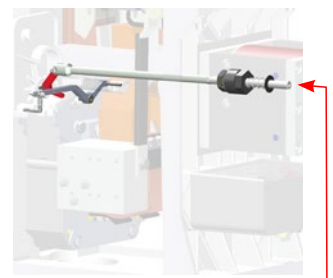

actuation

MANUAL CLOSING DEVICE

The manual closing device, mainly used for maintenance operations, enables to close and open the circuit breaker without low voltage supply and under no load.

UR26/40/46

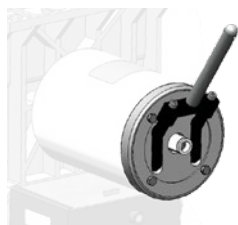

UR60/80

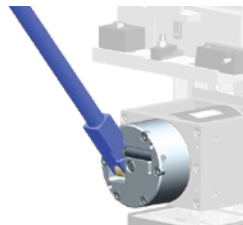

CONTACT WEAR INDICATOR (WI) OR OVERCURRENT RELEASE DETECTOR (I>) UR26/40/46

Installed on the rear side of the circuit breaker closing device, these options monitor the position of a rod linked to the breaker's moving contact, which rod actuates a micro-switch.

Based on the selected configuration the detector informs about:

- the reaching of the wear limit of the main contacts of the circuit breaker: function "contact wear indicator".
- the tripping of the circuit breaker through the overcurrent release: function "overcurrent release detector". These two functions cannot be selected together.

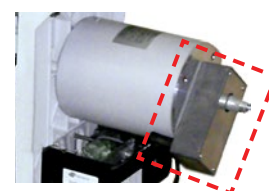
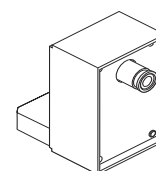

Contact wear indicator

DESIGNATION CODE FOR ORDERING

- Be sure to establish the designation code from our latest version of the brochure by downloading it from our website "www.secheron.com".
- Be careful to write down the complete alphanumeric designation code with 22 characters when placing your order.
- The customer shall write down the setting of maximum current release value (I_d) in its order form.
- For technical reasons some variants and options indicated in the designation code might not be combined.
- The bold part of this designation code defines the device type, and the complete designation defines the identification number of the product, as displayed on the identification plate attached to the product.

Note: page 16: Designation code - Order form

⁽¹⁾ ECO-Drive is only available for UR26/40/46 with Harting HAN® 32 connector and 24, 48, 60, 110 V_{DC} control voltage.

⁽²⁾ UR60/80: only for electric holding

⁽³⁾ Rectified 230 V_{AC}

⁽⁴⁾ In case control type "Electric holding with ECO-Drive is selected (line 15), select "No" for Varistor on Coil (line 17)

Example of customer's choice:	UR	40	81	S	1	E	E	0	F	0	A	C	0	0	0	0	0	S	B
Line:	10	11	12	13	14	15	16	17	18	19	20	21	22	23	24	25	26	27	28

DESIGNATION CODE

Line	Description	Designation	Standard	Options	Customer's choice
10	Product type	UR	UR		UR
11	Conventional free air thermal current	2,600 A 4,000 A 4,600 A 6,000 A 8,000 A	26 40 46 60 80		
12	Rated operational voltage UR26/40/46/60/80 UR26/40/46/60/80 UR26/40	900 V 1,800 V 3,600 V	81 82 64		
13	Application	Fixed Installation	S		S
14	Arc chute installation (Refer to page 9 for selection) UR26/40/46 (Arc chute 81), UR26/40/46/60/80 (Arc chute 82) UR26/40 (Arc chute 64) UR60/80 (Arc chute 81) For other selection, refer to codification table page 9	Opening on LV connector side Type SE Vertical removal	1 2 8	
15	Control type	Electric holding - without ECO-Drive Magnetic holding - without ECO-Drive Electric holding - with ECO-Drive (1)	E	M 4	
16	Nominal supply voltage UR26/40/46 UR26/40/46/60/80 UR26/40/46/60/80 (2) UR26/40/46/60/80 UR26/40/46/60/80 UR60/80 (2) UR26/40/46/60/80	24 V _{DC} 48 V _{DC} (60) 64 V _{DC} 110 V _{DC} 125 V _{DC} 200 V _{DC} (3) 220 V _{DC}	A C G E R K J	K	
17	Varistor in coil (4)	No Yes (battery voltage)	0	1	
18	Direct overcurrent release (bidirectional) UR26 UR26/40/46 UR40/46 UR60 UR80 For other selection, refer to codification table page 6 Direct overcurrent release (unidirectional) - UR60/80	1.4 - 2.7 kA 2.0 - 8.0 kA 4.0 - 15.0 kA 14.0 - 18.0 kA 18.0 - 24.0 kA W	A D F L P W	
19	Indirect release (shunt trip) UR26/40/46 (includes horizontal manual release) UR26/40/46 (includes horizontal manual release) UR60/80 (includes horizontal manual release) UR60/80 (includes horizontal manual release)	No BIM5 BIM6 BIM7 BIM8	0	5 7 4 6	
20	Auxiliary contacts UR26/40/46/60/80 UR26/40/46	5a + 5b - (switch PF) 5a + 5b - (switch CO)	A	B	
21	LV connector type on circuit breaker UR26/40/46/60/80 UR40/46	Harting type HAN® 32 EE Veam type 22 pins	C	B	
22	Manual release UR26/40/46/60/80 UR26/40/46/60/80	No Horizontal Vertical	0	1 2	
23	Manual closing device (not compatible with line 25 nor 26) UR26/40/46/60/80	No Yes	0	3	
24	Position indicator	No Yes	0	2	
25	Overcurrent release detector (not compatible with line 23 nor 26) UR26/40/46	No Yes	0	1	
26	Contact wear indicator (not compatible with line 23 nor 25) UR26/40/46	No Yes	0	1	
27	HV main connection - UR26/40/60/80 (according to pages 7 and 8) HV main connection - UR46 (according to pages 7)	Standard	S B		
28	Digit for Sécheron internal purpose UR26/40/46 UR26/40/46 UR26/40 UR60/80	Arc chute 81 Arc chute 82 Arc chute 64 Arc chutes 81 & 82	B C G L		

The low voltage connector must be ordered separately:

Harting type HAN® 32 EE: SG104063R10100 SG104063R10800 SG104063R10900

Value of the setting of maximum current release value (Id): [A]

(1)(2)(3)(4) For notes, please refer to previous page.



Sécheron SA
Rue du Pré-Bouvier 25
1242 Satigny - Geneva
CH-Switzerland

www.secheron.com
Tel: +41 22 739 41 11
Fax: +41 22 739 48 11
ess@secheron.com

Signature:

Name:

Place and date: